



More Crop Per Drop

Using Simple Drip Irrigation Systems for Small-scale Vegetable Production

Manuel Palada, Surya Bhattarai,
Deng-lin Wu, Michael Roberts,
Madhusudan Bhattarai, Ros Kimsan,
David Midmore





AVRDC – The World Vegetable Center is an international nonprofit research institute committed to alleviating poverty and malnutrition in the developing world through the increased production and consumption of nutritious, health-promoting vegetables.

AVRDC – The World Vegetable Center
P.O. Box 42
Shanhua, Tainan 74199
TAIWAN

Tel: +886 6 583 7801
Fax: +886 6 583 0009

Email: info@worldveg.org
Web: www.avrdc.org

AVRDC Publication: 09-723
ISBN 92-9058-174-3

Editor: Maureen Mecozzi
Cover design: Chen Ming-che
Publishing Team: Kathy Chen, Chen Ming-che, Vanna Liu, Lu Shiu-luan

© 2011 AVRDC – The World Vegetable Center
Printed in Taiwan



This work is licensed under the Creative Commons Attribution-ShareAlike 3.0 Unported License.
To view a copy of this license, visit <http://creativecommons.org/licenses/by-sa/3.0/tw/> or send a letter to Creative Commons, 171 Second Street, Suite 300, San Francisco, CA, 94105, USA.

Suggested citation

Palada M, Bhattarai S, Wu DL, Roberts M, Bhattarai M, Kimsan R, Midmore D. 2011. More Crop Per Drop: Using Simple Drip Irrigation Systems for Small-scale Vegetable Production. AVRDC – The World Vegetable Center, Shanhua, Taiwan. AVRDC Publication No. 09-723. 83 p.

Project Partners

International Development Enterprises



Central Queensland University



Photos and illustrations courtesy of IDE India, IDE Cambodia, NSW DPI - Australia, Surya Bhattarai, Madhusudan Bhattarai, Manuel Palada, Brent Rowell, A. Susila, Deng-lin Wu, Eric Simone, R. Stizaker

More Crop Per Drop

Using Simple Drip Irrigation Systems for Small-scale Vegetable Production

Manuel Palada, Surya Bhattarai, Deng-lin Wu, Michael
Roberts, Madhusudan Bhattarai, Ros Kimsan, David Midmore

Contents

Chapter 1: Introduction to Drip Irrigation	6
Chapter 2: Simple Drip Irrigation Systems	14
Chapter 3: Installation of a Simple Drip Irrigation System	22
Chapter 4: Drip Irrigation Scheduling	38
Chapter 5: Determining Soil Texture	44
Chapter 6: Determining Soil Water Status	50
Chapter 7: Estimating Crop Water Use	60
Chapter 8: Irrigation Water Quality	70
Chapter 9: Irrigation System Assessment	74
Chapter 10: Socioeconomic Evaluation of Small-scale Drip Irrigation	76
References	81

Preface

By producing vegetables year-round, small-scale growers can increase their incomes and enhance the diets of their families and communities. Vegetable crops respond well to irrigation, which helps to improve yield and quality, and increases the efficiency of other inputs.

Simple, low-cost drip irrigation systems can ensure small-scale producers benefit from water resources. This 10-chapter manual provides basic, step-by-step procedures for installing simple drip irrigation systems for different crops, climates, and soils. It addresses common problems, provides troubleshooting and maintenance tips, and offers irrigation scheduling guidelines to avoid under- or over-irrigation. Methods to determine soil types, water quality, water-holding capacity, crop coefficient, and crop water demand are illustrated. The information presented in this guide has been compiled from relevant literature, research and development projects, and is based on practical field experience.

This manual is intended as a guide for small-scale vegetable producers, and as a reference for extension agents to use in training and demonstrations. Agricultural input suppliers in rural and peri-urban areas may also find it a useful resource to support and promote drip irrigation.



CHAPTER 1

Introduction to Drip Irrigation



What is drip irrigation?

Drip irrigation, which is also known as *trickle irrigation* or *microirrigation*, is an irrigation method that allows a grower to control the application of water and fertilizer by allowing water to drip slowly near the plant roots through a network of valves, pipes, tubing, and emitters (Fig. 1). For many crops, switching from a conventional flood/furrow or sprinkler system to drip irrigation can reduce water use by 50 percent or more. Crop yields can increase through improved water and fertilizer management under drip irrigation. When drip irrigation is used with plastic mulch and raised beds, farmers can increase yield and improve the quality of vegetable crops. The combined use of drip irrigation, plastic mulch, and raised beds is known as *plasticulture*.

Drip irrigation is not applicable to all farms. However, when properly managed, it can reduce labor and production costs while improving productivity. Small-scale growers should evaluate the advantages and disadvantages of drip irrigation to determine the benefits for their farms.

Advantages of drip irrigation

- Less water can be used. Drip irrigation requires less than half of the water for flood or furrow irrigation and less than three-quarters of the water for sprinkler irrigation.
- Lower operating pressure means reduced energy costs for pumping.

- Water use efficiency is increased because plants can be supplied with water in precise amounts.
- Disease pressure may be less because plant leaves remain dry.
- Water is applied directly to the plant root zone. No applications are made between rows or other non-productive areas, resulting in better weed control and significant water savings.
- Field practices such as harvesting can continue during irrigation because areas between rows remain dry.
- Fertilizers can be applied efficiently through the drip system.
- Irrigation can be done under a wide range of field conditions.
- Compared to sprinkler irrigation, soil erosion and nutrient leaching can be reduced.

Disadvantages of drip irrigation

- Higher initial investment compared to other irrigation methods.
- Requires regular maintenance and high-quality water. If emitters are clogged or the tape damaged, the tape must be replaced.
- The water application pattern must match the planting pattern. If emitters are not properly spaced, root development maybe restricted and plants may die.
- Drip tubes may be lifted by wind or displaced by

animals unless covered with mulch, fastened with wire anchor pins, or lightly covered with soil.

- Drip lines can be easily cut or damaged by other farming operations, such as tilling, transplanting, or manual weeding with a hoe. Damage to drip tape caused by insects, rodents, or birds may create large leaks that also require repair.
- Water filtration is necessary to prevent clogging

of the small emitter holes.

- Compared to sprinkler irrigation, water distribution in the soil is restricted.
- Drip-tape disposal causes extra cleanup costs after harvest. Planning is needed for drip-tape disposal, recycling, or reuse.

A typical drip irrigation system has seven major components:

Components of a drip irrigation system

1. Water Source
2. Control Valve
3. Filter
4. Main Pipe
5. Sub-main Pipe
6. Lateral Pipe
7. Microtube/Emitter/Baffle/Dripper
8. Vegetable bed

ABCD - Area for Expansion

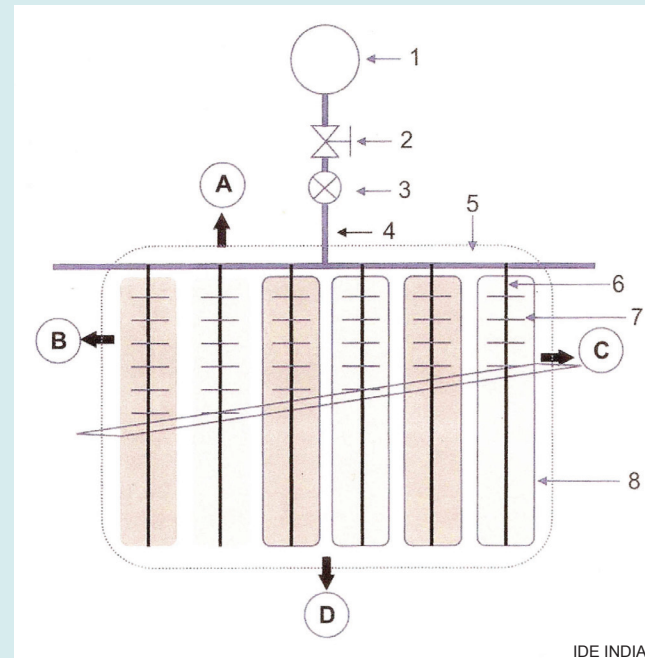

Figure 1. Layout of a typical drip irrigation system

Water source

The water for irrigation can come from wells, streams, ponds, tanks, rain, recycled water from wastewater treatment plants or other sources. (Fig. 2)



Figure 2. Irrigation water sources: (l) river canal and (r) pond.

Delivery system

The delivery system of any drip irrigation system (Fig. 3) consists of:

- mainline
- sub-main (also called a *header*)
- feeder tubes or connectors
- drip lines (tubes or tape)

The role of the delivery or distribution system is to convey the water from the source to the field. Delivery systems may be above ground (easily movable) or underground (less likely to be damaged). Pipes are most commonly made of PVC or polyethylene plastics. The size and shape of the distribution system may vary from field to field and from farm to farm.

- The **mainline** delivers water from the source (pump, filtration system, etc.) to the *sub-mainline*. The mainline is made of hard plastic and is joined to the sub-mainline by a T-connector.
- The **sub-main** delivers water to the *drip tubes* or *drip tapes* through *feeder tubes* or *connectors*. The sub-mainline is made of durable polyethylene pipe or hose.
- **Feeder tubes** or **connectors** connect each drip tube or tape to the sub-mainline. Feeder tubes are made of plastic and can be inserted directly into the sub-mainline and the drip tube or tape.
- **Drip lines** can be made from tubes or tape. *Drip tubing* has an inner and outer chamber to allow for even water distribution over a range of conditions. Most tubing is polyethylene black plastic, 4 to 8 mm thickness, with holes (*emitters*) at intervals of 20-60 cm. *Drip tape* is a low-cost alternative to drip tubing.

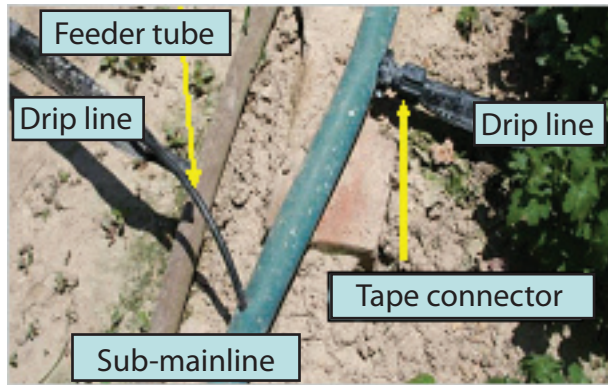

A

BRENT ROWELL



B



C

Figure 3. Components of a drip irrigation delivery system: (a) sub-main connected to tape drip lines by feeder tube and connector; (b) emitter connected to tube drip line (c) sub-mainline, connector, tape drip line.

Connectors

Many types of connectors can be used to join mainlines, sub-mains, drip tubes, and drip tape (Fig. 4).



Figure 4. Various types of drip connectors.

Filters

Filters are essential to the operation of a drip system. Screen filters or disc filters are used for well and municipal water. Filters remove dirt and solid particles from irrigation water that can clog the drip system (Fig. 5).

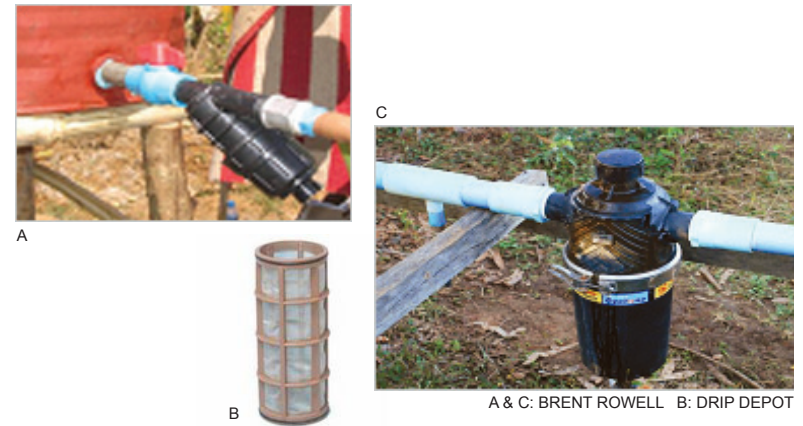
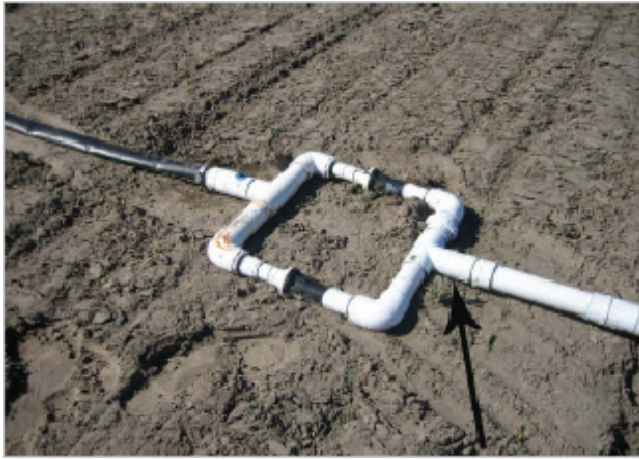

Figure 5. (a) Screen filter unit and main valve; (b) 155-mesh screen filter; (c) disc filter

Pressure regulator

Pressure regulators are installed in-line with the system to regulate water pressure at a given water flow (Fig. 6). Regulators help prevent surges in water pressure that could damage the system components.



ERIC SIMONE

Figure 6. Pressure regulators installed side-by-side allow a greater flow rate.

Valves or gauges

A zone system using valves to open and close various lines can be used to water several fields or sections of fields from one water source (Fig. 7). A backflow/anti-siphon valve is a necessity for a system using a well or municipal source if fertilizers or chemicals are to be injected into the line. Hand-operated gate or ball valves or electric solenoid valves can be used to automate the system using a time clock, water need sensor, or automatic controller box.



ERIC SIMONE

Figure 7. A fixed pressure gauge.

Injectors

Injectors allow the application of air, fertilizer, chemicals, and maintenance products into the irrigation system (Fig. 8). It is necessary to use an anti-siphoning device (also called a backflow-prevention device) when fertilizer, chemicals, or any other products are injected into a drip irrigation system. This device ensures water always moves from the water source to the field; it prevents chemicals or fertilizers from polluting the water source.



BRENT ROWELL

Figure 8. Fertilizer injector with tank (l) and bucket (r) containers.

Controllers

Controllers allow the user to monitor how the drip irrigation system performs (Fig. 9). These controls help ensure the desired amount of water is applied to the crop throughout the growing season. Controllers include pressure regulators, water meters, pressure gauges, timers, and soil moisture measuring devices.

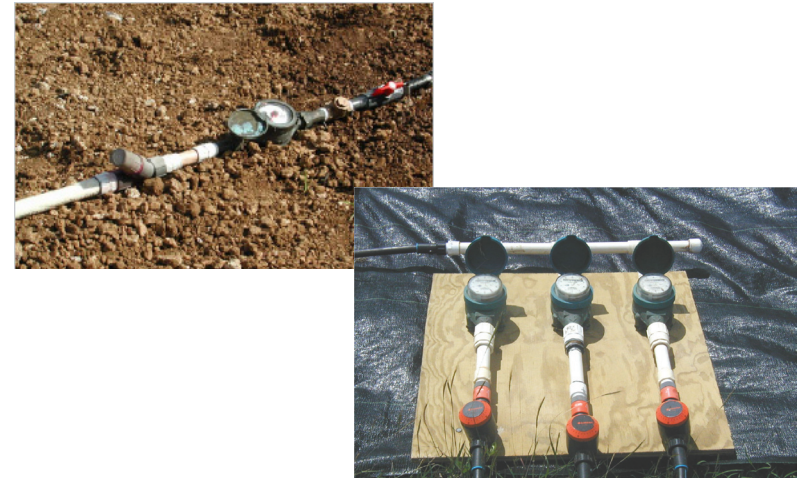

BRENT ROWELL

Figure 9. (l) Water meter installed near the field; (r) water meter and timer to control flow of irrigation water.

CHAPTER 2

Simple Drip Irrigation Systems



Some simple drip irrigation systems

International Development Enterprises (IDE) has developed simple, affordable low-cost drip irrigation systems for smallholder vegetable growers. These systems include:

- Bucket Kit
- Family Nutrition Kit
- Drum Kit
- Customized System
- Combo Kit

IDE also offers simple, low-cost water pumps to use with the drip irrigation kits. These include several types of wooden and metal treadle pumps.

Bucket Kit (Fig. 10)

Features

- A pre-assembled kit to irrigate vegetables in home gardens.
- Has a 20-liter bucket with one or two rows of lateral drip lines 5 to 10 meters in length, depending on the space available.
- Can irrigate up to 20 square meters.
- Bucket can be hung from a tree or pole 1 meter high.

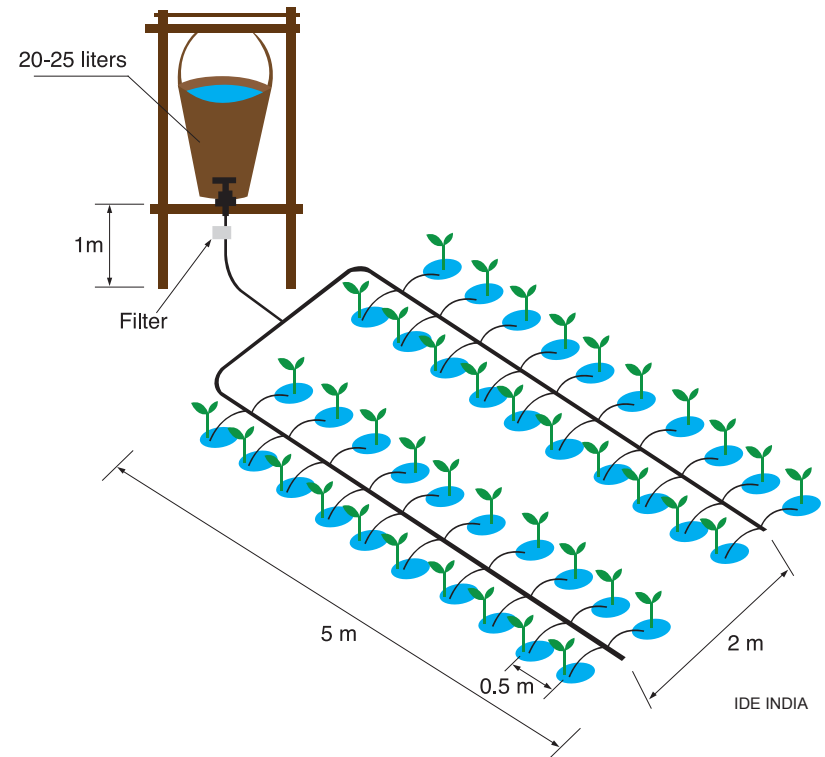

Figure 10. A simple bucket kit for irrigating a small vegetable garden plot of approximately 20 square meters.



M. PALADA

Figure 11. Family Nutrition Kit for home gardens. The water bucket is replaced by a 20-liter double plastic bag.

Family Nutrition Kit (Fig. 11)

Features

- A variant of the bucket kit, it replaces the bucket with a low-cost 20-liter double-layer plastic bag.
- Has a 20-liter water storage unit, screen filter, on/off valve, sub-main pipe, and four rows of KB drip lateral drip line 5 meters in length with 44 20-cm long microtube emitters.
- Can irrigate an area of 20 m². Expandable up to 40 m².
- Provides irrigation for 44 to 88 vegetable plants, depending on the crop and spacing.

Drum Kit (Fig. 12)

Features

- A pre-assembled kit useful for semi-commercial vegetable gardens.
- The drum kit comprises a 200-liter water storage drum, barrel, tank, or similar container placed at an average height of 1 meter to allow the water to flow by gravity. The drum requires a minimum planted area of 100 m².
- Has five or more rows of lateral drip lines 10 to 20 meters long, depending on crop spacing and shape of the plot.

The irrigated area can be expanded up to 1000 m² by using a larger drum placed at an average height of 1 to 1.5 m.

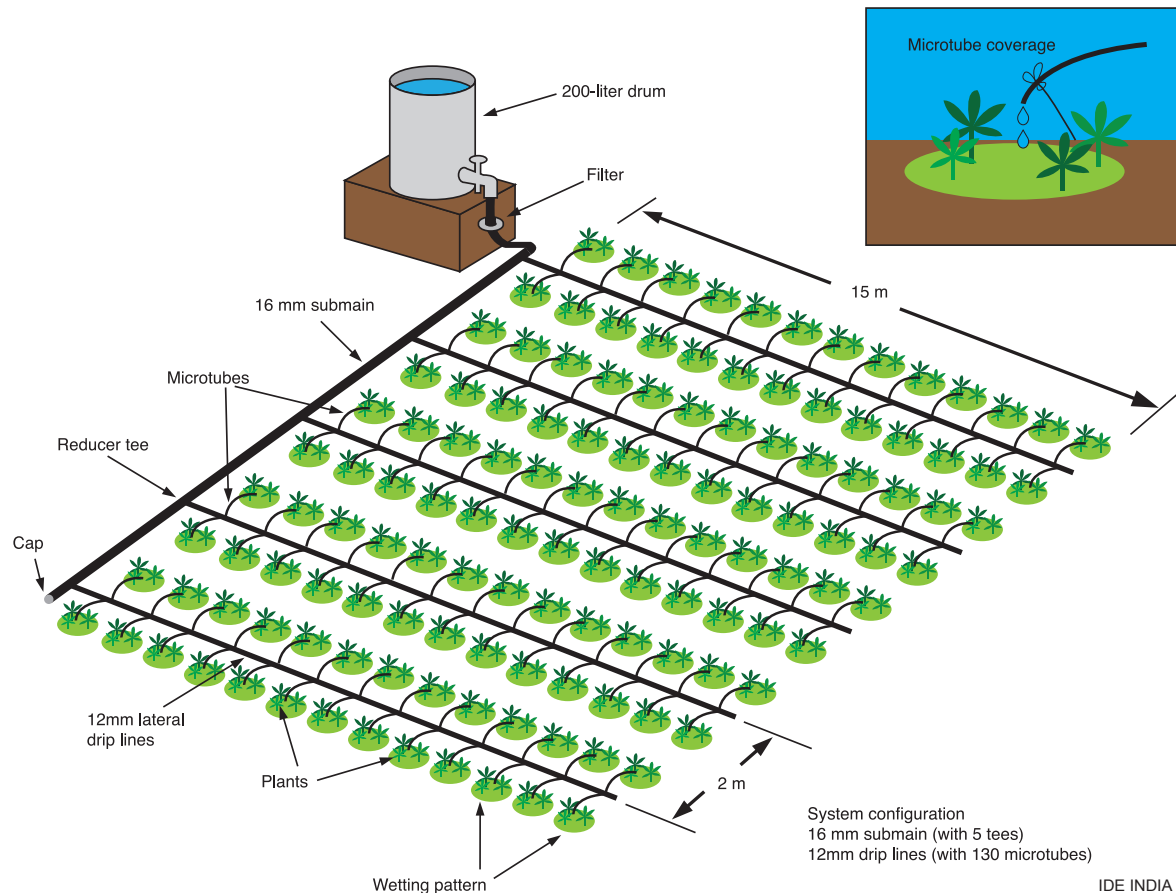

Figure 12. A drum kit with drip for semi-commercial vegetable production.

KB Drip (Fig. 13)

A new innovation in low-cost drip irrigation

Krishak Bandu (KB) or “Farmer’s Friend” uses lay-flat lateral drip lines with a wall thickness of only 0.125-0.25 mm, which expand to 16-mm in diameter when filled with water. Microtubes are used as emitters to provide uniform water application. The cost in India is around US \$600 per ha for closely spaced crops. The inlet pressure head for the KB Drip system can range from 0.5 to 3 meters. KB Drip kits of various sizes are described in Table 1. KB Drip is popular due to its lower cost, small package sizes, ability to operate at very low pressure, ease of installation and use, and uniformity of water distribution.

Features

- KB Drip systems can be customized to suit the needs of the farmer, crops, and field shape.
- Typically meant for larger areas of 1000 m² and upward.
- By procuring different components of the KB Drip system, the kit can be installed using simple rules of thumb.
- For smallholding up to two hectares, farmers can easily plan and lay the system in the field with some support from local fitters.

Customized systems

KB Drip kits can be customized to meet the specific needs of farmers, different crops, and fields of various shapes and sizes.



M. PALADA

Figure 13. KB low-cost lay-flat drip irrigation system adjustable to different plot and field sizes.

Table 1. Specifications for various sizes of KB Drip Kits*

Specification	KB Drip Kit (EDK 20)	KB Drip Kit (EDK 100)	KB Drip Kit (EDK 500)	KB Drip Kit (EDK 1000)
Area Coverage	20 m ²	100 m ²	500 m ²	1000 m ²
Microtubes	60	300	1500	3000
Number and Length of Lateral Drip Lines	4 lines 5.0-m long	10 lines 10-m long	40 lines 12.5 m long to each side of the sub-main	40 lines 25m long to each side of the sub-main
Sub-main Outer Diameter and Length	16-mm OD 3 m	16-mm OD 9 m	32-mm OD 20 m	50-mm OD 20 m
Screen Filter Size	12 mm inlet & outlet	16 mm inlet & outlet	25 mm inlet & outlet	32 mm inlet & outlet
Operating Head (Height of Tank)	1 meter	1 meter	2 meter	2 meter
Emitter Flow	2.5 liters/hour	2.2 liters/hour	2.4 liters/hour	2.2 liters/hour
Water Storage	20 liters	200 liters	1000 liters	2000 liters
Price (US\$)**	3	12	38	60
Crops	Vegetable crops: Tomato, Eggplant, Onion, Cabbage, Rapeseed, Paprika, Cauliflower, Garlic, Watermelon, Cucumber, Lettuce, etc. The larger systems can be used for short-duration fruit crops such as banana and papaya with a few modifications.			

*Basic specifications: Microtube emitters 0.3 m long, 1.2 mm inner diameter; emitter spacing 0.30 m intervals; KB Drip tape laterals of Linear Low Density Polyethylene (LLDPE) material; row spacing at 1 m intervals along LLDPE sub-mains.

**Prices ex-factory.

Source: IDE-India

Combo Kit: Components (Figs. 14-15)

Rope pump: The pump capacity of a hand rope pump is 2.4 m³ per hour (10 m depth well), enough to irrigate 2000 tomato plants. The water outlet of the multipurpose model is high, so a water tank can be filled directly.

Cement tank: Instead of a metal drum a cement tank may be used with the advantages of lower cost per liter, longer-lasting material (no corrosion), and larger volume (500 to 5000 liters). The tank can be constructed with local materials and skills, and also can be used for fish production. An 800-liter cement tank consists of: 100 bricks, 1 kg of steel wire, 2 bags of cement, and 6 bags of sand. The tank is round and reinforced with steel wire on the outside of the bricks. A simple filter is included in the tank; by using PVC caps, no valves are needed. The height of 1 meter is enough for drip irrigation to function.

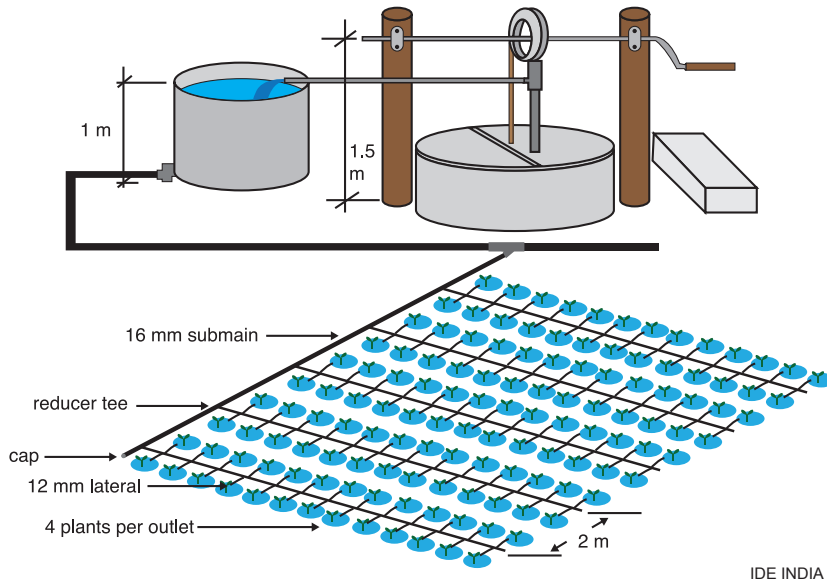

Figure 14. A combo kit consisting of cement tank, rope pump, and irrigation set up for semi-commercial production.

Figure 15. Drawing water from well with a manually operated rope pump.

M. PALADA

Costs: Depending on the local situation, the costs for a basic irrigation set is US\$ 70 to 140 including a rope pump (for wells 1 to 40 m deep), cement tank (800 liters), and drip system (for 120 m², 520 tomato plants). The irrigated area can be expanded to 0.5 ha depending on well depth, number of plants, and duration of irrigation.

Treadle Pump (Fig. 16)

The treadle pump (commonly known as a pedal pump) is a water-lifting device similar in principle to the hand pump. A hand pump consists of a single barrel or cylinder, which one has to pump with one's hands; the treadle pump has two cylinders, and the operator can step on the pedals to lift water. One person—a man, woman, or even a child—can operate the pump by pressing on two foot pedals or while holding on to a bamboo or wooden frame for support. IDE India has developed four models of the pump designed for distinct soil, water, and income conditions:

- 3.5-inch pump (metal barrels) with bamboo treadles
- 3.5-inch pump (metal barrels) with metal treadles
- 5-inch pump (metal barrels) with metal treadles
- 5-inch concrete pump (PVC barrels) with wooden pedals

3.5-inch treadle pumps, bamboo or metal treadles

- 3.5-inch diameter barrel.
- Pump weighs approximately 14 kg.
- Ideal for lifting water from water table depth ranging from 4.5 to 6 meters (maximum lift 8 m).
- Water output is approximately 0.8 to 1.25 liters per second.
- The lifted water can be stored in the tank for drip irrigation or can be applied to plots in furrow irrigation.



IDE INDIA

Figure 16. A low-cost pump with bamboo treadle that can be used for furrow irrigation or to fill the tank for drip irrigation.

CHAPTER 3

Installation of a Simple Drip Irrigation System



Installing a simple drip irrigation system





The Horticulture Easy Drip (HED) kit is a simple drip irrigation system designed for small-scale vegetable production in developing countries where water resources are scarce, water control systems are poor, and access to irrigation water is limited.



The HED kit allows the user to assemble all parts needed to make an irrigation system (Table 2). All of the irrigation accessories are readily available and affordable. The kit may be adapted for 5, 10, 15 or more rows of vegetables, depending on the size of vegetable plot. The size of the water tank, and the length and number of laterals will depend on plot size, but in this chapter HED for 100 m² is used as an example.





This irrigation system does not require an electrical power supply, as the system works by gravity. When a 100-liter bucket or tank of water is raised 1.5 meters above the ground (measured from the bucket bottom) sufficient pressure is generated to force the water from the bucket through the irrigation tape on the ground.

Tubes are connected through the bottom or the side of the bucket or tank to the irrigation tape. Water drips from the tape into the soil and provides enough moisture for a vegetable garden to feed a family of three to four.

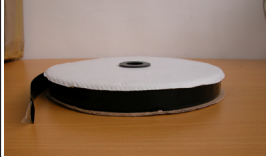
Table 2: Components of HED kit (IDE India, 2007)

Item	Count	Description	Picture
HED set	12	The set contains all fittings except the drum and the base.	
Thin cloth piece	1	Cotton, 1 m x 1 m. To use as filter from the source to the drum.	
Tap and checknuts	3 pieces	1 male-threaded adapter in the tap. 2 rubber washers 1 female-threaded check nut	
Filter screen set	1	Black PVC with inlet strainer filter screen and outlet Follow the arrow for the direction of the flow.	

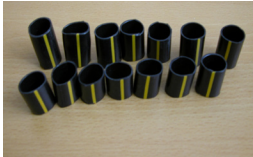
Tees 16 mm	12	These connect sub-main section and sub-mains to laterals.	
End caps	2	These end caps attached at the distal end of sub-main. Stops water flow at the end of the drip line.	
Poly tube roll	1	16 mm for the sub-main.	
Easy drip tape roll	102 m	This flat tape used as laterals does not have slits. It will be connected to sub-mains.	

Microtube 25 cm long	315 m	Microtubes have an orifice of 0.5 mm for the discharge of water. These are inserted through the flat tape at the appropriate spacing for the crop.	
Punch thumb	3	These sharp-ended punches are used to make holes to insert microtubes into the flat tape.	
Sleeve 16 mm	11	Sleeves are end caps for all flat laterals. They can be removed while flushing the system.	
Joiner 16 mm	1	To re-join the flat or sub-main in case there is a break.	

Component Assembly (Figs. 17-20)

Figure 17. Steps in connecting lateral pipe (tube) to sub-main line (tube)

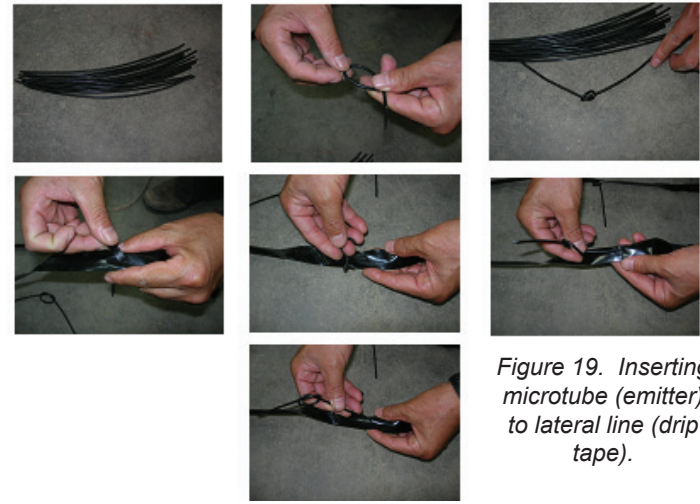
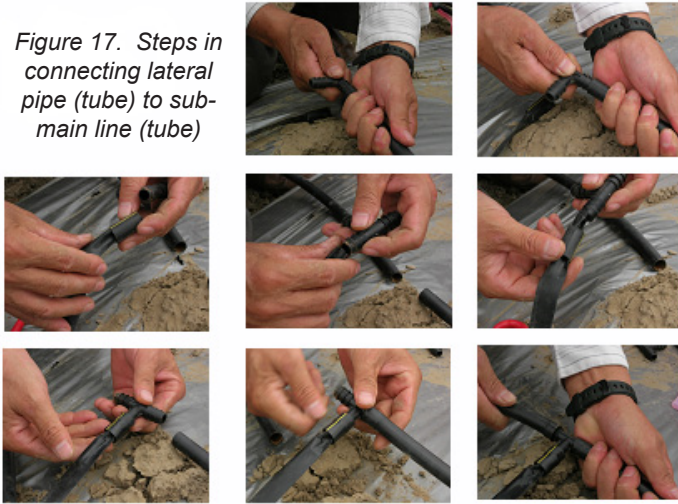

Figure 19. Inserting microtube (emitter) to lateral line (drip tape).

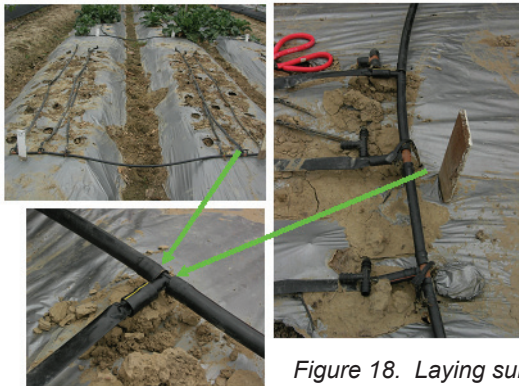

Figure 18. Laying sub-main lines with laterals on raised beds.

Figure 20. Laying out drip lines with inserted drippers (emitters).



Installing a drip kit

Step 1: Location and site selection

- At least 6-8 hours of full sun a day
- Away from large trees
- As level as possible – flat slope
- Use a fence to keep out animals
- Plot size: 20 m long x 10 m wide

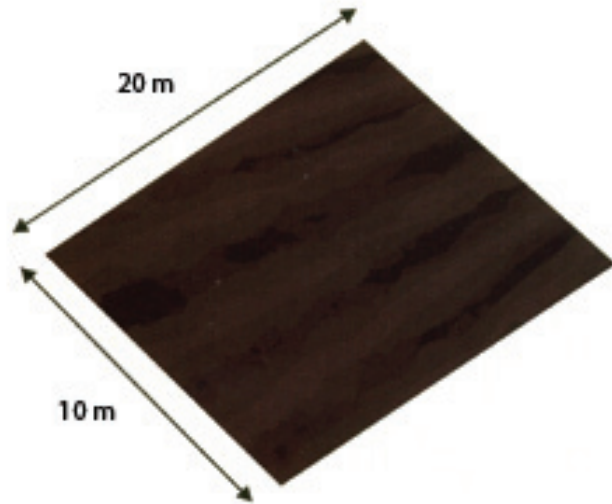

Step 2: Prepare the land by loosening the soil; mix in sufficient compost.

Step 3: Fix the tap on the drum and tighten it with checknut and gaskets by rotating checknut from inside (Do not rotate the tap from outside).

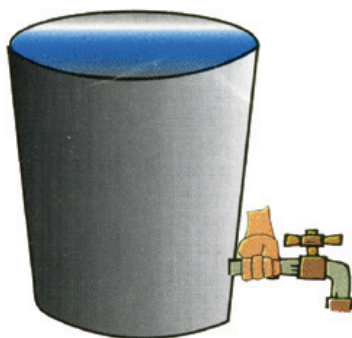

Step 4: Prepare a platform or wooden stand 1 m high at the center of one side of the plot and fix the drum on the platform or wooden stand.

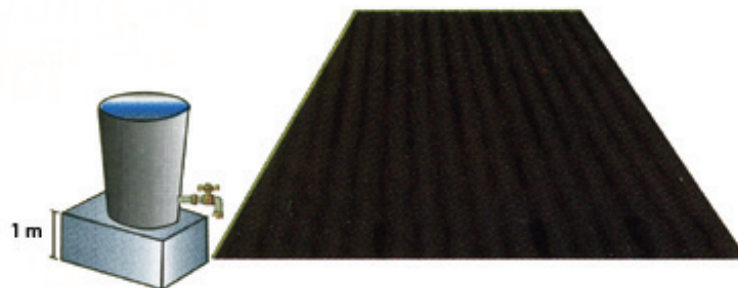

Step 5: Take 16 mm polytube coil, cut 1.5 meter piece and connect it to the tap.

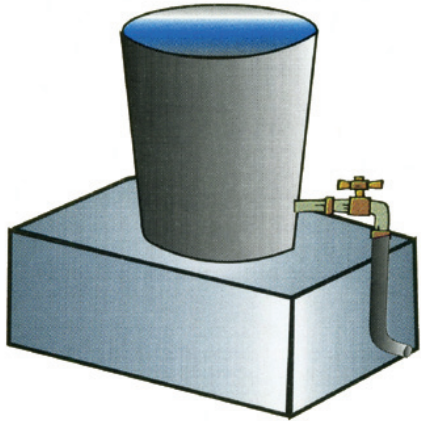

Step 7: Cut 25 cm piece of 16 mm polytube and connect it back to the filter. Connect 16 mm tee to the other end of 25 cm piece.

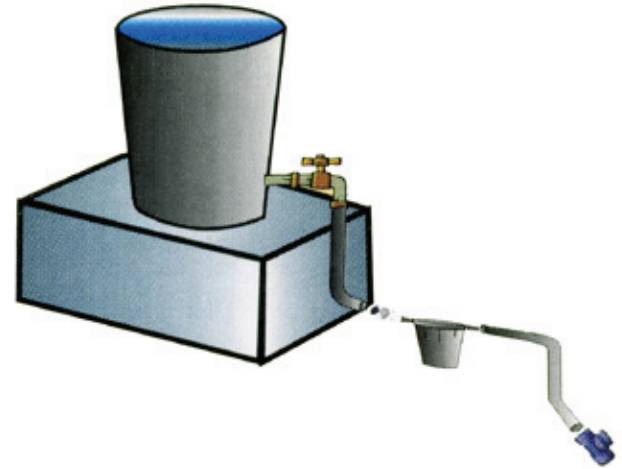

Step 6: Connect the filter to the other end of the 1.5 m piece on the ground.

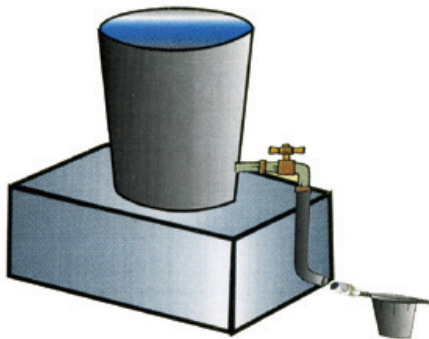

Step 8: Cut 1 meter of 16 mm polytube and connect it to 16 mm tee. Similarly connect all other 16 mm Tees (total of 10 pieces) at 1 meter spacing.

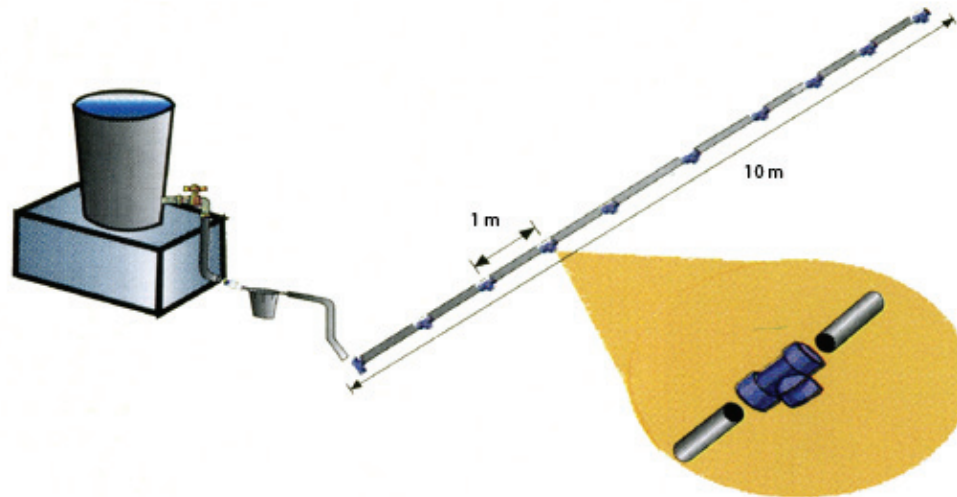

Step 9: *Connect the end cap at end of the 16 mm polytube after last 16 mm tee.*

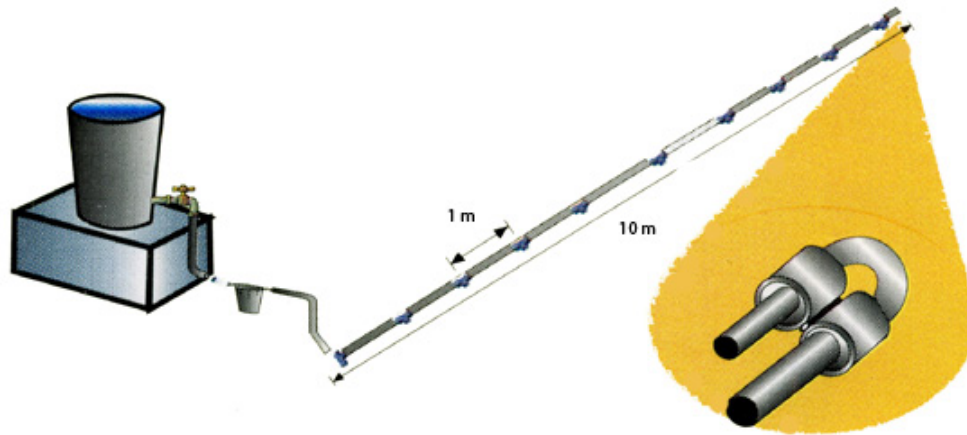

Step 10: Take easy drip tape roll and connect one end to 16 mm Tee with the help of 16 mm polytube sleeve. (Pass the tape through the sleeve, connect it to the tee and put the sleeve over it).

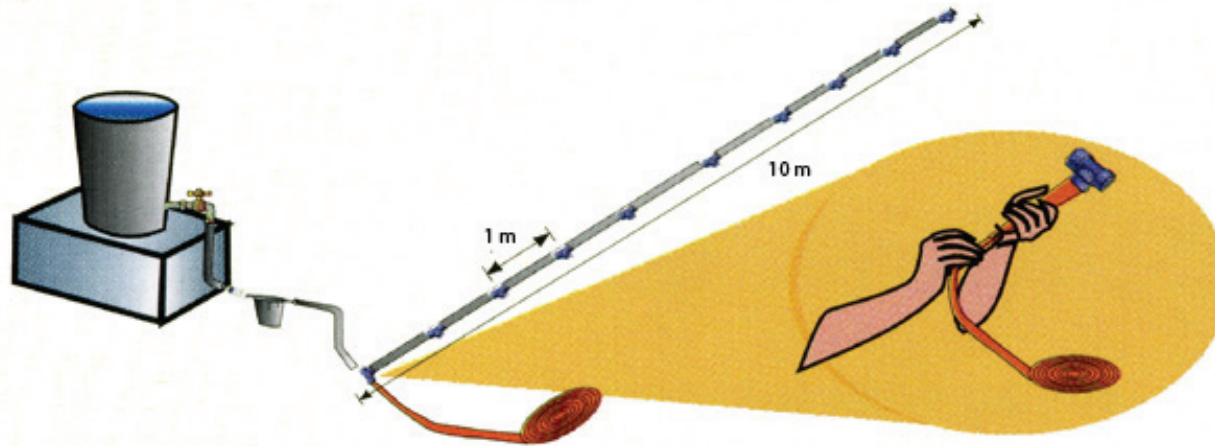

Step 11: Lay easy tape on the ground and cut at 10 m length. Similarly connect all 10 laterals to 16 mm tees.

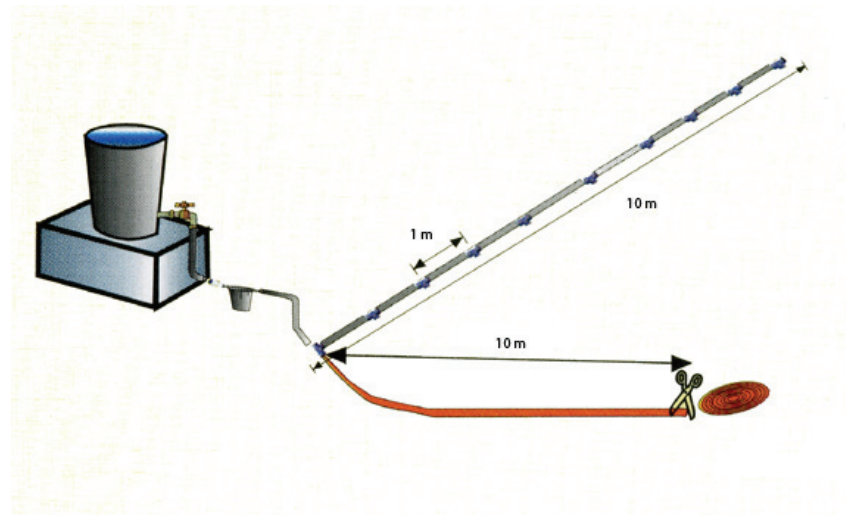

Step 12: *Cut 3 cm piece of easy tape, fold the end of easy tape and insert 3 cm piece to close the end. Repeat the procedure for all 10 easy tape laterals.*

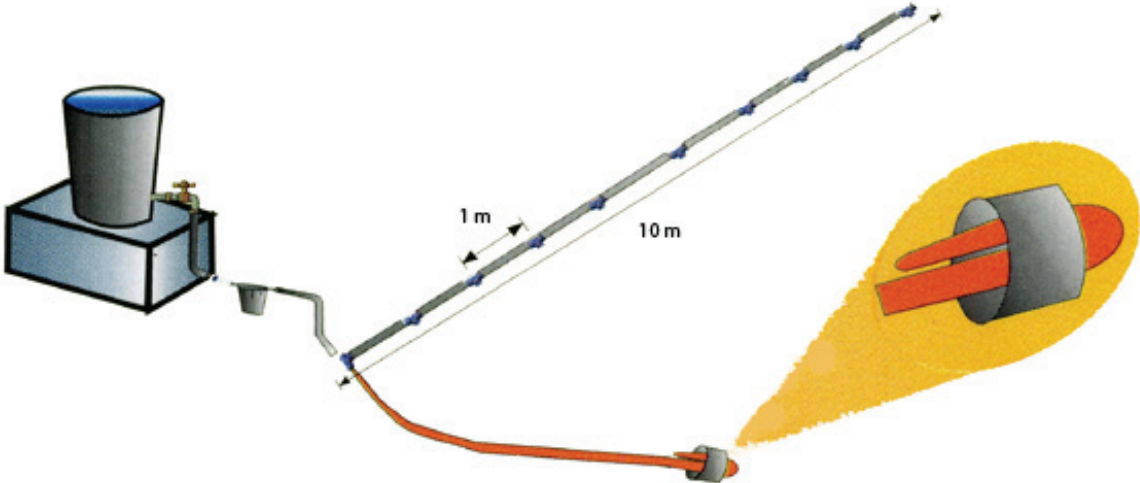

Step 13: Put the cloth on the tank and fill it with water. Open the tap and fill all the easy tape laterals with water.

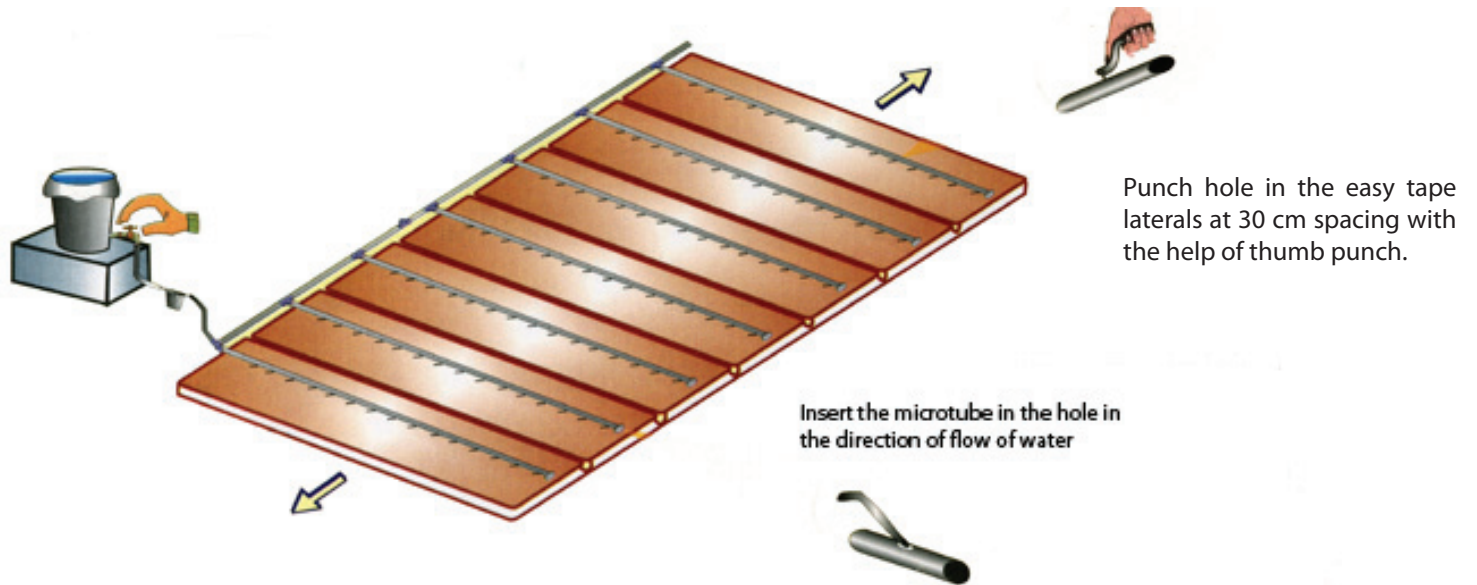

Step 14: *Now the system is installed and ready to use.*

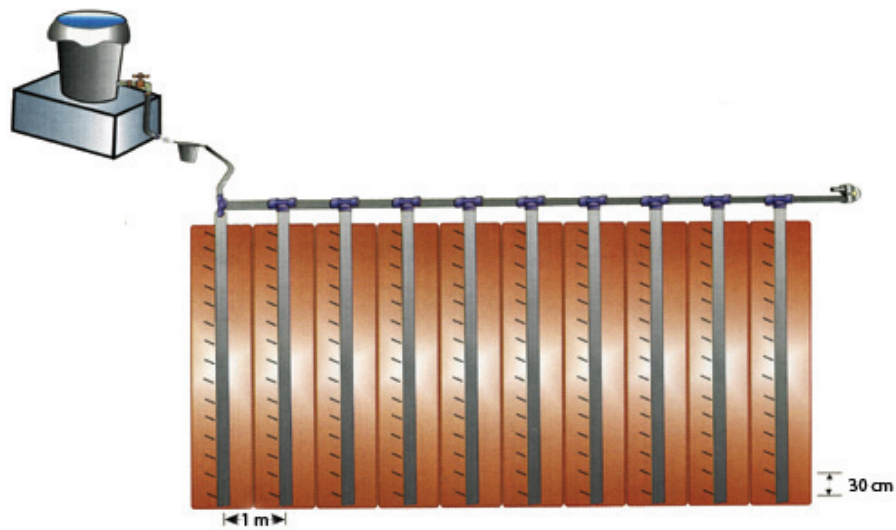

Troubleshooting, repair and maintenance

Clogging

Clogging reduces or stops water from dripping through the tape. To avoid clogging, open the end caps and flush out the particles once a week (Fig 21). The dirt in the piping can be sucked out or blown out easily when dry. Regular cleaning of the filter and double filtering of water before pouring into the drum minimizes clogging (Fig. 22).

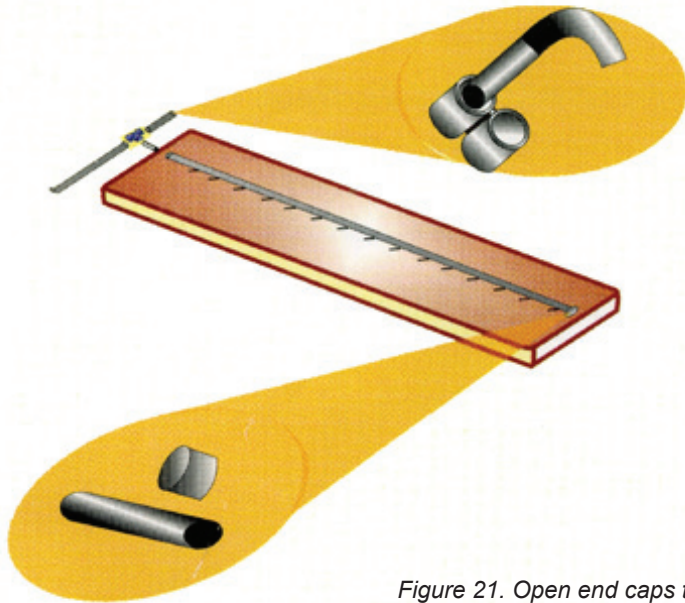
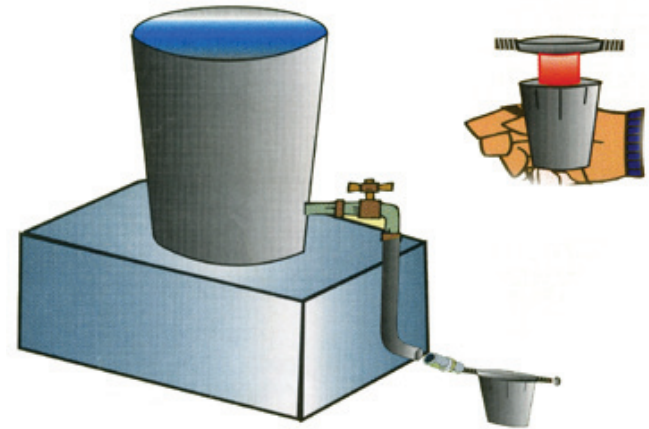

Figure 21. Open end caps to flush out particles that clog the system.

Figure 22. Removing filter cap to allow cleaning particles from inner mesh.



Repairing leaks in drip lines

Holes in drip tape can be plugged with a small piece of tubing that has been heated with a match or torch and crimped with pliers (Fig. 23). Enlarge the hole with a nail before inserting plug.

A round piece of wood also works; it swells when wet and makes a tight fit.



Figure 23. Heated tubing (a) crimped with pliers (b) and inserted or plugged in drip tape hole (c)

Breakage

To repair drip tape, cut away damaged area and connect the two pieces with a 16 mm joiner provided in the bag.

End-of-Season Maintenance

With care, the drip kit should last 5 to 7 years. At the end of each season:

- Remove sleeves from the far ends of the drip tape.
- Pour water in bucket to flush out tape and replace sleeves.
- Store the bucket so that it will not be damaged by rodents.
- Remove stopper from adapter and rinse filter screen if bucket takes longer than usual to empty. Do not remove screen from stopper or rub screen with fingers.
- Leave drip tapes in place, but place a stone over the end of each tape to prevent from blowing away.
- Protect the tapes from animals.

CHAPTER 4

Drip Irrigation Scheduling



Drip irrigation scheduling

Irrigation scheduling is the decision of when and how much water should be applied to vegetable crops in a field. The purpose of irrigation scheduling is to determine the exact amount of water to apply to the field and the time for application thereby maximizing irrigation efficiencies. Irrigation scheduling saves water and energy.

Irrigation criteria and scheduling

Irrigation criteria are the indicators used to determine the need for irrigation (Broner, 1993). The most common irrigation criteria are soil moisture content and soil moisture tension. The less common types are irrigation scheduling to maximize yield and irrigation scheduling to maximize economic (net) return. The final decision depends on the irrigation criterion, strategy and goal. Farmers need to define a goal and establish an irrigation criterion and strategy.

To illustrate irrigation scheduling, consider a farmer whose goal is to maximize yield. Soil moisture content is the irrigation criterion. Different levels of soil moisture trigger irrigation. For example, when soil water content drops below 70 percent of the total available soil moisture, irrigation should start. Soil moisture content to trigger irrigation depends on the farmer's goal and strategy. In this case, the goal is to maximize yield. Therefore, the farmer will try to keep the soil moisture content above the critical level. If soil moisture levels fall below this level, the yield may be lower than the maximum potential yield. Thus, irrigation is applied whenever the soil water content level reaches the critical level.

If the farmer's goal is to maximize net return, an economic irrigation criterion is needed, such as net return. This is the income from the crop less the expenses associated with irrigation. Irrigation scheduling enables the farmer to apply the exact amount of water to achieve the goal. This increases irrigation efficiency without knowing how much was applied. Also, water distribution across the field is important to derive the maximum benefits from irrigation scheduling and management. Accurate water application prevents over- or under-irrigation. Over-irrigation wastes water, energy and labor; leaches expensive nutrients below the root zone, out of reach of plants; and reduces soil aeration, and crop yields. Under-irrigation stresses the plant through constraints in water availability and causes yield reduction.

Advantages of irrigation scheduling

- Can rotate water among various fields to minimize crop water stress and maximize yields.
- Reduces cost of water and labor through less irrigation, making maximum use of soil moisture storage.
- Lowers fertilizer costs by holding surface runoff and deep percolation (leaching) to a minimum.
- Increases net returns by increasing crop yield and quality.
- Minimizes waterlogging, reduces drainage requirements.
- Assists in controlling root zone salinity problems.
- Results in additional returns: "saved" water can be used on noncash crops that otherwise would not be irrigated during water-short periods.

Irrigation Scheduling Methods

Irrigation scheduling methods consist of an irrigation criterion that triggers irrigation and an irrigation strategy that determines how much water to apply. Irrigation scheduling methods differ by the irrigation criterion or by the method used to estimate or measure this criterion. A common and widely used irrigation criterion is soil moisture status.

Table 3 compares the different methods of irrigation scheduling by monitoring soil moisture content or tension. The methods described in the table measure or estimate the irrigation criterion.

Table 3. Methods of irrigation scheduling (Broner, 1993).

Method	Measured Parameter	Equipment Needed	Irrigation Criterion	Advantages	Disadvantages
Hand feel and appearance of soil.	Soil moisture content by feel	Hand probe.	Soil moisture content.	Easy to use; simple; can improve accuracy with experience.	Low accuracies; field work involved to take samples.
Gravimetric soil moisture sample.	Soil moisture content by taking samples.	Auger, caps, oven.	Soil moisture content.	High accuracy	Labor intensive including field work; time gap between sampling and results.
Tensiometers.	Soil moisture tension.	Tensiometers including vacuum gauge.	Soil moisture tension.	Good accuracy; instantaneous reading of soil moisture tension	Labor to read; needs maintenance; ineffective at tensions above 0.7 atm.
Electrical resistance blocks.	Electric resistance of soil moisture.	Resistance blocks, AC bridge (meter).	Soil moisture tension.	Instantaneous reading; works over larger range of tensions; can be used for remote reading.	Affected by soil salinity; not sensitive at low tensions; needs some maintenance and field reading.
Water budget approach.	Climatic parameters: temperature, radiation, wind, humidity and expected rainfall, depending on model used to predict ET.	Weather station or available weather information.	Estimation of moisture content.	No field work required; flexible; can forecast irrigation needs in the future; with same equipment can schedule many fields.	Needs calibration and periodic adjustments, since it is only an estimate; calculations cumbersome without computer.
Modified atmometer.	Reference ET.	Atmometer gauge.	Estimate of moisture content.	Easy to use. direct reading of reference ET.	Needs calibration; it is only an estimation.

Measuring soil moisture

There are different tools for the measurement of soil moisture based on soil moisture tension. The most common are tensiometers (Fig. 24-26). Although tensiometer moisture readings are accurate, they are quite expensive and complex for small farmers to operate. A much simpler tool for soil moisture measurement has been developed for practical use in the field. The Fullstop Wetting Front Detector (FSWD) is simple, accurate, and affordable for small-scale growers. It does not require wires, batteries, computer and loggers unlike most other soil moisture sensors.

The FSWD shows how deep the water has penetrated into the soil after irrigation. It also stores a sample of water from the soil so that fertilizer and salt levels can be monitored. It can be used to find out if irrigation water is too little or too much, assist in management of fertilizer and salts and detection of waterlogging. The wetting front detector shows how deep the wetting front has moved in the soil. The FSWD is buried in the soil and pops up an indicator flag when a wetting front reaches it. With drip irrigation it is possible to see the wetting front on the surface. A wet patch develops immediately under the emitter or dripper. Digging the soil away under two dripper reveals two columns of wet soil.

Wetting front detectors are usually used in pairs. The first is buried about 1/3 of the way down the active root-zone. The second is buried about 2/3 of the depth of the active

root zone (max depth of soil aimed to wet by irrigation). Figure 26 illustrates underwatering, adequate watering and overwatering scenarios on drip-irrigated crops. A tensiometer reading scale is shown in Table 4.

Table 4. Tensiometer readings (Goodwin, 2009)

Tensiometer Readings	
Centibars	Soil Moisture Status
1-10	saturation
10-20	field capacity
20-30	optimum (start drip irrigation)
30-60	start other types of irrigation
>70	stress range

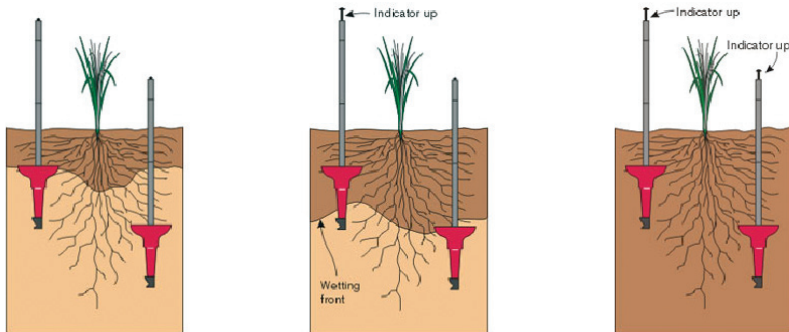

A. Too little water

B. About right

C. Too much water

A. If indicator of the shallow detector rarely pops up, then water is not moving deep enough to fill most of the root zone. More water should be applied.

B. The indicator of the shallow detector should pop up regularly after irrigation. The deeper detector should respond during periods of high demand for water.

C. If the indicators of both the shallow and deep detectors regularly pop up then water could be wasted. Apply less water or lengthen the period between irrigations.

Figure 24. Fullstop Wetting Front Detector showing soil moisture status. R. STIZAKER



(a)



(b)



(c)

M. PALADA

Figure 25. Soil moisture tensiometer: (a) in pairs at two depths, (b) installation on raised bed, (c) placement near the root zone.



(a) M. PALADA



(b) M. PALADA

Figure 26. Soil tensiometer placement in hot pepper drip irrigation field trial plot (a) and Fullstop Wetting Front Detector on drip irrigated tomato crop (b).

CHAPTER 5

Determining Soil Texture



Field determination of soil texture

Determination of soil texture is important in irrigation since water holding capacity of the soil depends on soil texture. Sandy soils generally have lower water holding capacity than clay soils. Therefore, irrigation water requirement of crops grown in sandy soils is higher than those grown in clay soils. Soil texture can be determined using two methods: 1) soil particle separation by suspension and 2) hand feel method.

Particle separation by suspension

Fig. 27 shows the separation of soil particle in suspension bottle to determine the amount of sand, loam and clay particles. Soil sample is placed in a container with clean water. The container is shaken for 1-2 minutes. After 1 minute, the sand particles will settle down while the loam particles settle down after one hour. Clay particles finally settle down after one day. Determine the soil texture using the soil texture triangle (Fig. 28). Read the depth of sand, silt and clay after settlement in the bottle, work out the percentage of these three components, and find out the soil texture class by triangulating the formation in the soil texture triangle.

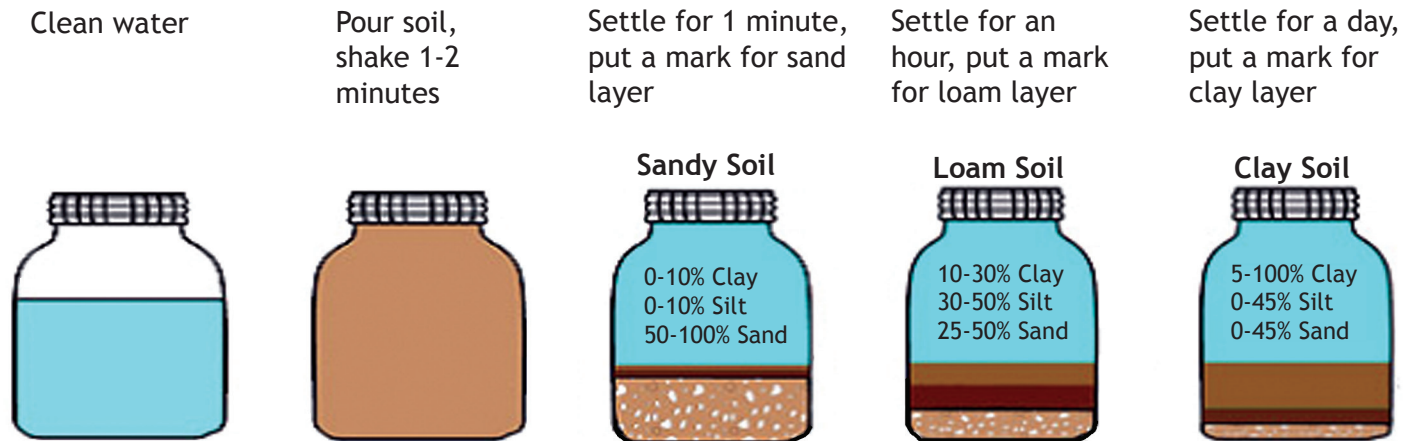

Figure 27. Field soil texturing method with suspension bottle. (Globe, 2005)

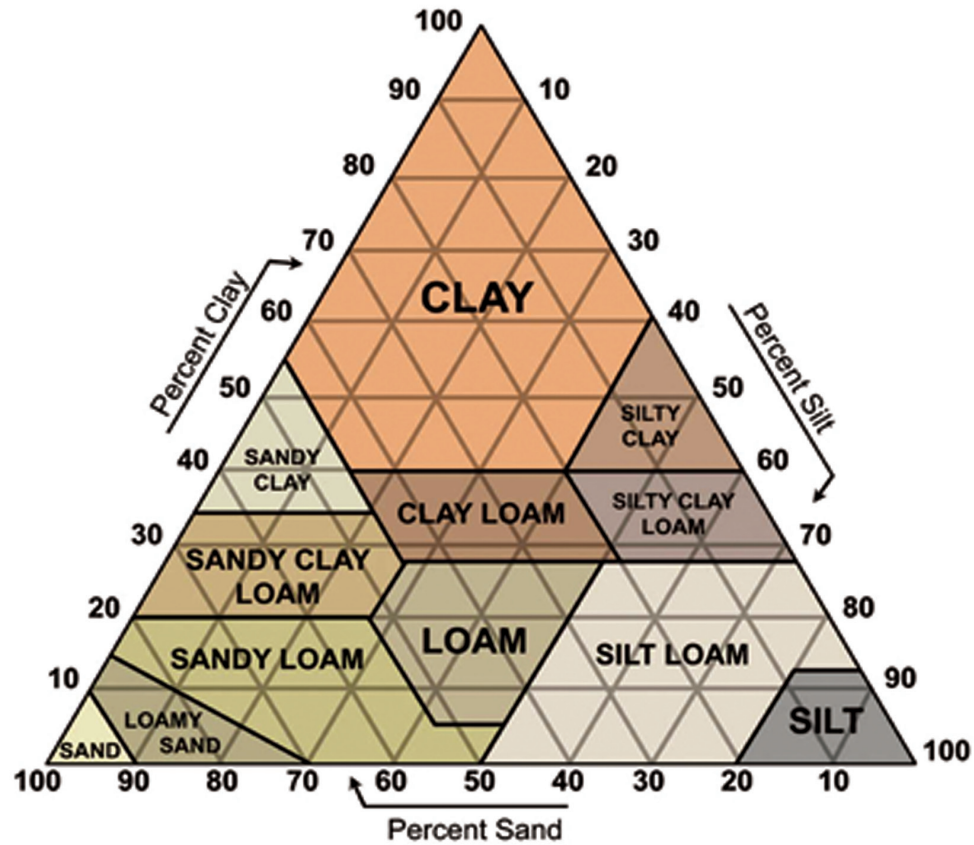

Figure 28. Soil texture triangle. (NSW DPI, 2008a)

Soil texture determination by hand

An alternative method for determining soil texture is by the feel method. Figure 29 shows the steps involved. How the soil feels in the hand and the length of ribbon formed will determine roughly the clay content (%) and the texture, as indicated in Table 5.

Collect sample	Sieve and prepare sample	Add water in handful soil	Knead, make ball. No ball formation = sand	Make soil ribbon, measure length to know texture
				

Figure 29. Steps in determining soil texture using the feel method. (NSW DPI, 2008a)

Table 5. Key to soil texture by feel (NSW DPI, 2008a)

Soil texture	Ribbon length	How the soil feels	Clay (%)
Sand (S)	Nil	No ball forms. Can't be molded, sand grains adhere to fingers	<5
Loamy sand (LS)	5 mm	Slight coherence, sand grains of medium size can be sheared between thumbs and fore finger	5-10
Clayey sand (CS)	5-15 mm	Slight coherence, sticky when wet, sand grains sticks to fingers, discolor fingers, little or no organic matter	5-10
Sandy loam (SL)	15-25 mm	Coherent ball but very sandy to touch, dominant sand grains are of medium size and readily visible	10-20
Light sandy clay loam	20-25 mm	Coherent ball sand to the touch, dominant sand grains are of medium size and readily visible	15-20
Loam (L)	About 25 mm	Forms a thick ribbon, pliable ball, smooth spongy and no obvious sandiness. Greasy to touch if organic matter is present	-
Sandy clay loam (SCL)	25-44 mm	Strongly coherent ball, sandy to touch, medium sand grains visible in a finer matrix	20-30
Clay loam (CL)	40-50 mm	Strongly coherent and plastic ball, smooth to manipulate	30-35
Sandy clay (SC)	50-75 mm	Plastic ball, sand grains can be seen and felt	35-40
Light clay (LC)	50-75 mm	Plastic, smooth feel easily worked, molded and rolled in to rod. Rod forms a ring without cracking	35-40
Medium clay (MC)	>75 mm	Smooth plastic ball, can be molded into rod without cracking, resistance to shearing	45-55
Heavy clay (HC)	>75	Smooth, very plastic ball, firm resistance to shearing, mold into rods, stiff plasticine. Very sticky and strongly coherent. Rod forms a ring without cracks.	>50

NOTES

CHAPTER 6

Determining Soil Water Status



Determining soil water status

Soil water status

Soil moisture level determines the timing of irrigation. Soil moisture status can range from dry to saturated (Fig. 30). Maintaining soil moisture at field capacity during the critical growth period is important for vegetable production.

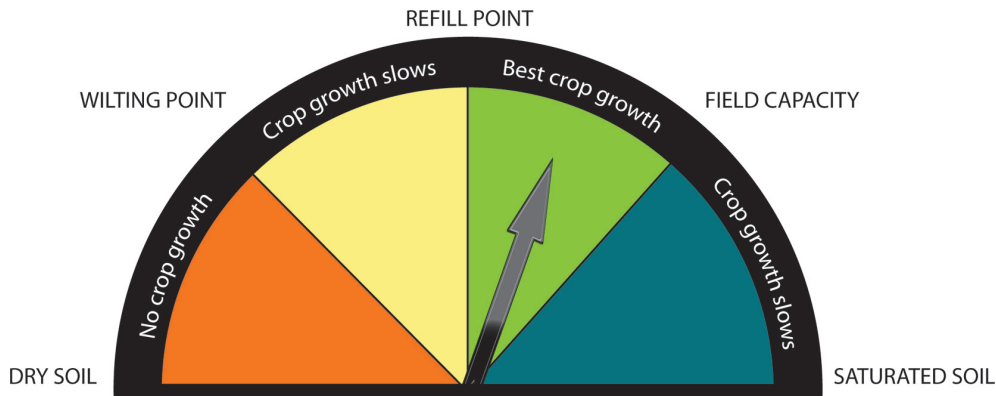

Figure 30. Soil moisture status and relative crop growth. (Ramsey, 2007)

Terms describing soil moisture status:

Saturation

All pores in the soil are filled with water, soil water content = % porosity.

Field capacity

Soil water content after free drainage (24-48 hrs) of saturated soil.

Refill point

The water content of the soil below which the plant exhibits some form of stress, and a drop in yield, it is not constant down the soil profile, and the advent of stress might be identified by a drop in daily use water and roots extracting water at greater depth.

Permanent wilting point

Soil water content when plants have extracted much water and wilt, but will recover if rewatered.

Unavailable water

Soil water content that is strongly attached to soil particles and aggregates, and cannot be extracted by plants. Exemplified by water content less than permanent wilting point, i.e. when plants have extracted all of the water they can and do not recover if rewatered.

Terms describing soil water content

Water held in the soil is described by the term water content, quantified gravimetric (g water/g soil) and volumetric (ml water/ml soil) basis. Terms to describe water content and illustrated in Figure 31 are:

Gravitational water

Water (amount) held by soil between saturation and field capacity.

Water holding capacity:

Water (amount) held between field capacity and wilting point.

Plant available water

Portion of the water holding capacity that can be used by plant. As general rule, plant available water is 50% of the water holding capacity. From field capacity to the stress point it is easy to get the water. From the stress point to the permanent wilting point plants find it much harder to draw water from the soil and their growth is stunted. Below the permanent wilting point no further water can be removed and the plant dies.

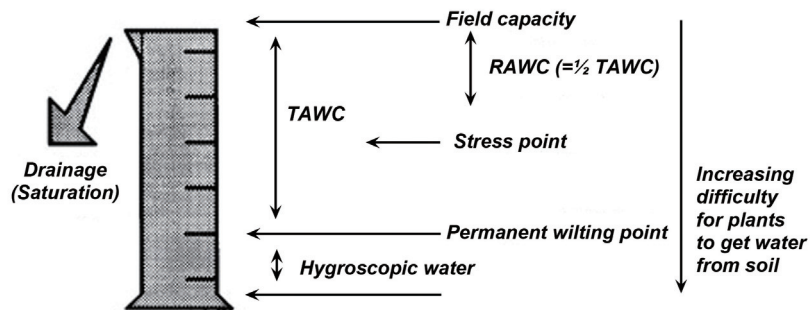

Figure 31. Soil water holding characteristics and terms. (Luke, 2006)

Total available water content (TAWC)

Readily available water (RAW)

The amount of water crop roots can utilize per cm of soil depth, which greatly varies according to the texture of the soil

(Table 6). Water available to a crop depends on rooting depth and soil texture; soils differ in their ability to hold water, and water that can be extracted by plant roots. RAW in the root zone of a crop (mm) is the cumulative total of the depth in cm of each soil layer multiplied by the appropriate RAW value for the soil texture of that layer (Table 7).

The amount calculated represents water holding capacity of soil in the crops root zone, that is, the amount of irrigation water (mm) that it takes to fill the soil profile.

To schedule irrigation, one should know how much water a soil can hold that is available to the crop. The soil surrounding a plant's roots store the water it needs to live, grow and produce a crop. This water is held by the soil with increasing strength as the soil dried out. Refill point is the point at which the plant has used all water that is readily available. Beyond refill point, as the soil dries out the plant needs to work a lot harder to extract water, placing stress on the crop. The difference between field capacity (FC) and refill point (RP) is called RAW. RAW is water stored in the soil that is easily extracted by the plant. Unless trying to stress the crop, irrigation should aim to maintain RAW at all times. The amount of RAW available to crop will vary with soil type, crop rooting depth and irrigation system.

Steps in identifying readily available water

Step 1: Dig a hole: Dig a hole within the root zone of your crop.

Step 2: Identify the effective root zone (area where the main mass of roots is found).

Step 3: Identify different soil layers (measure depth, and calculate thickness of each layer).

Step 4: Identify percentage of gravel/stone in each layer (use a 2 mm sieve, and visually estimate %).

Step 5: Identify soil texture(s)

Step 6: Calculate RAW

Step 6.1: Identify the depth of the effective root zone.

Step 6.2: Identify the depth of different soil layers within the effective root zone.

Step 6.3: Determine the soil texture and % stone/gravel of each layer.

Step 6.4: Select the crop water tension group (Table 6) and identify the RAW value for each soil texture/layer (mm/100 mm).

Step 6.5: Reduce the RAW figure(s) by % stone/gravel in the soil.

Step 6.6: Multiply the thickness of each soil layer by its adjusted RAW value.

Step 6.7: Add up the RAW for each soil layer to obtain the total root zone RAW.

Table 6. RAW and Available Water (AW) values for different soil textures (Ramsey, 2007)

Water Tension*	To -20 kPa	To -40 kPa	To -60 kPa	To -100 kPa	To -150 kPa
	A	B	C	D	E
	Soft crops such as vegetables and some tropical fruits.	Most fruit crops and table grapes. Most tropical fruits.	Lucerne, most pasture, grapes*; crops such as maize and soybeans.	Annual pastures and hardy crops such as cotton, sorghum and winter cereals.	Available Water (AW) is the total water available in the soil.
Soil texture	Readily Available Water (RAW) (mm/m)				AW (mm/m)
Sand	35	35	35	40	60
Sandy loam	45	60	65	70	115
Loam	50	70	85	90	150
Clay loam	30	55	65	80	150
Light clay	25	45	55	70	150
Medium to heavy clay	25	45	55	65	140

Tension is 0 kPa at saturation point. The figures are only approximate.

*Except when partial rootzone drying is being practiced on wine grapes, should be irrigated before -60 kPa is reached.

Table 7: Calculating rootzone RAW: Example 1 (Ramsey, 2007)

White Radish (Daikon) is growing in 0.3 m of sandy loam on top of 0.5 m of light clay. For a soil pit at this site the calculations would be:

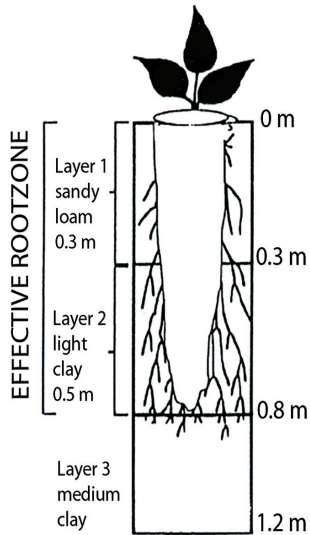

STEP 1: Identify and measure the soil layers	STEP 2: Determine the soil texture of each layer	STEP 3: Identify the texture RAW for each soil layer and crop. Daikon (Table 6, column B)	STEP 4: Multiply the thickness of each soil layer by its texture RAW.	STEP 5: Add up the RAW for each layer.	STEP 6: Identify the effective rootzone.	STEP 7: Add up the RAW in the effective rootzone.
0 to 0.3 m = 0.3 m	Sandy loam	60 mm/m	0.3m X 60 mm/m = 18 mm	18 mm		18
0.3 to 0.8 m = 0.5 m	Light clay	45 mm/m	0.5 m X 45 mm/m = 22.5 mm	22.5 mm		22.5
0.8 to 1.2 m = 0.4 m	Medium clay	45 mm/m	0.4 m X 45 mm/m = 18 mm	18 mm		
				= 58.5 mm		= 40.5 mm

The effective rootzone RAW for this example is 40.5 mm

Calculation of RAW: Example 2

A citrus crop growing in a sandy loam soil containing 20% stone, with an effective root depth of 0.3 m and a strategy to irrigate at - 40 kPa would have the following calculation:

From table of the RAW for sandy loam at - 40 kPa = 60 mm/m.

As the soil contains 20% stone we must reduce the RAW by 20%. To reduce RAW by 20%, multiply by 0.8.

Adjusted RAW = 60 mm/m x 0.8 = 48 mm/m.

Hence, for a rooting depth of 0.3m, total Root zone RAW = 48mm/m x 0.3 m = 14.4mm.

If irrigating with a drip or micro spray system that does not wet the entire cropped area, then convert RAW mm to RAW liters.

Converting RAW (mm) to liters for drip systems

1 mm depth of water = 1 L applied to 1 m²

Where irrigation water and plant roots are evenly distributed over the whole planting area, water storage and plant water use can be measured in mm. Where drip irrigation is used, the irrigation water and roots are only distributed in a smaller area in the field.

In these cases, it is often easier to use liters to describe both the water use and water storage in the plant root zone. This also allows simple calculation of irrigation time as the discharge from drip systems is commonly reported in liters/hour.

Calculating liters of water held in the crop root zone

The volume of root zone wet by the drip system will depend on the size and shape of the wetting pattern.

Overlapping drippers

Where the drip patterns overlap it can be assumed that a wetted strip or “sausage” shaped wetted pattern is produced. In this case, the volume of water held in the soil can be estimated from the width and length of the wetted strip and the root zone Readily Available Water (RAW).

Volume stored (L) = wetted width (m) x wetted length (m) x root zone RAW (mm)

For example: for a 1.5 m wetted width, 3 m crop spacing and root zone RAW of 14 mm, the volume of readily available water = 1.5 x 3 x 14 = 63 Liters RAW per plant. Note: If the root zone of your crop does not have access to entire wetted strip you need to adjust the dimensions of the wetted area in your calculation. This is particularly important in young plantings where roots may have access to only a small portion of the wetted strip.

Non-overlapping drippers

Where wetting patterns do not overlap, it is necessary to calculate the wetted volume assuming a cylinder, sphere or cone shaped wetting pattern. For example, if a root zone with a RAW of 14 mm is wetted by a dripper with a cylindrical wetting pattern and a radius of 0.2 m the volume of readily available water will be:

$\pi r^2 \times \text{root zone RAW (mm)}$

(πr^2 is the area of a circle where pi (π) is equal to 3.14)

$3.14 \times (0.2 \times 0.2) \times 14 = 1.8 \text{ L/plant (Radius 0.2 m)}$.

If there is more than one dripper per plant multiply this by the number of drippers to get the total litres of RAW available to each plant.

Calculating hours of irrigation

Irrigation time can be determined from the volume of water that can be held in the root zone wetted area and the discharge rate of the drippers.

Irrigation time (hours) = Volume RAW (L) ÷ dripper discharge rate (L/hour)

Example 1: Overlapping drippers with a RAW of 63 liters per tree, 2 L/hr drippers spaced 0.5 meters apart. Each plant has access to the full 3 m wetted length between plants.

3 m wetted length ÷ 0.5 m dripper spacing = 6 drippers per plant. 6 drippers per plant x 2 L/hr drippers = 12 L/hr/ plant. 63 L/RAW/plant ÷ 12 L/hr/plant = 5 hours and 15 minutes irrigation time.

Example 2: Non-overlapping drippers with a RAW of 1.8 liters per dripper and 8 L/hr drippers. 1.8 L/RAW/dripper ÷ 8 L/hr = 0.225 hours = 13.5 minutes (multiply time in hours by 60 to determine number of minutes)

Note: Using RAW to determine irrigation time will give the maximum time needed to irrigate to refill the RAW. If the soil dries out beyond the moisture content that is considered readily available to the crop then it will need to irrigate for a longer period.

Measuring dripper discharge

Although manufacturers normally specify the output of the drippers it is best to check the actual discharge as your system may be operating at a different pressure or affected by blockages and wear. Discharge can be checked by digging a hole under the dripper and using a container to measure the volume emitted over a known period. Randomly check drippers across the irrigation system including drippers close to and farthest from the mainline. In this way the uniformity of delivery by the emitters, and uniformity of distribution of water across the field can be assessed and required adjustment can be made.

Infiltration rate (IR)

IR is the measure of speed at which water can move through a soil profile, and it is largely related to soil texture, and affected by bulk density, organic matter, surface soil stability and ground cover. IR of a soil determines the maximum rate at which irrigation should be applied. If irrigation exceeds IR it will result in soil puddling and run-off. The infiltration rates for different soil types are presented in Table 8.

Table 8. Example values of soil water characteristics for various soil textures (Ramsey, 2007)

Soil texture	Field capacity (mm/mm)	Permanent wilting point (mm/mm)	Available water capacity ¹ (mm/mm)	Infiltration rate (mm/h)
Coarse sand	0.10	0.05	0.05	22
Sand	0.15	0.07	0.08	13
Loamy sand	0.18	0.07	0.11	12
Sandy loam	0.20	0.08	0.12	10
Loam	0.25	0.10	0.15	7
Silt loam	0.30	0.12	0.18	6
Silty clay loam	0.38	0.22	0.16	5
Clay loam	0.40	0.25	0.15	4
Silty clay	0.40	0.27	0.13	3
Clay	0.40	0.28	0.12	2

¹AWC for -8kPa to -60kPa. These are example values, considerable variations from these values with in each soil textural class may be noted in the field.

Water holding capacity of the soil varies greatly from 10 - 60 mm.

Water holding capacity = Field capacity (-8kPa) - refill point (approximately -60kPa).

The quantity of water applied in one irrigation should not exceed the infiltration rate; otherwise water will be lost below the root zone and/or added to the water table if one exists.

Dept of Rooting Zone

Effective rooting depth is determined by crop type (Table 9) and presence of impeding layers of soil to root growth (Fig. 32).

Rooting depth is generally regarded as the zone where roots are easily observed. Where root growth is restricted by an impeding chemical and physical barrier, the effective rooting depth is the depth to this layer. The rooting density decrease with depth as illustrated in Figure 32. Rooting depth must be taken into consideration for irrigation.

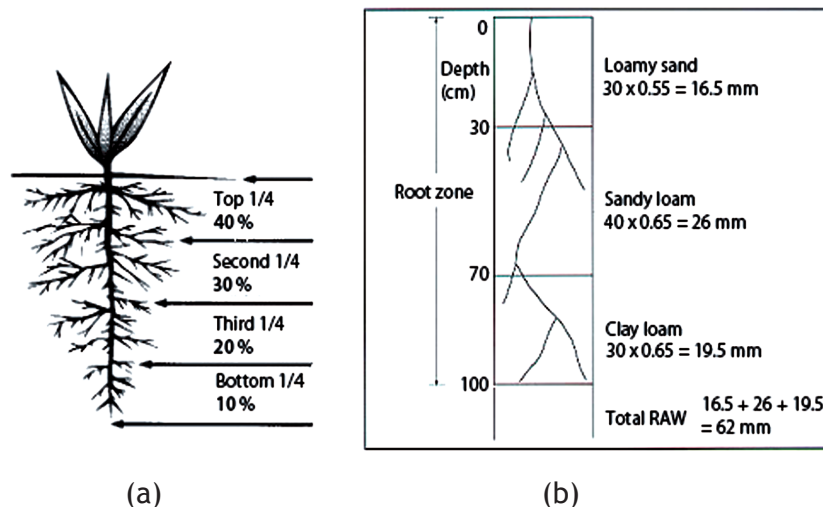

Figure 32. Illustration of the effective root zone (a) and soil heterogeneity and root distribution in the soil profile (b). (Ramsey, 2007)

Table 9. Maximum rooting depths of irrigated crops in a medium textured soil (Evans et al.,1996)

Rooting depths			
30 cm	45 cm	60 cm	75 cm
Flowers	Field peas	Peanuts	Alfalfa
Strawberry	Potatoes	Field corn	Cotton
Kale	Tobacco	Soybean	
Lettuce	Beans	Asparagus	
Mustard	Beet	Cantaloupes	
Spinach	Broccoli	Sweet corn	
Onion	Cabbage	Egg plant	
Pepper	Cauliflower	Okra	
	Carrots	Watermelon	
	Collards		
	Peppers		
	Turnips		
	Rutabagas		
	Cucumber		
	Tomatoes		

CHAPTER 7

Estimating Crop Water Use



Estimating crop water use

Scheduling irrigation based on crop water use minimizes chances of under- or over-watering. Proper irrigation also ensures crop growth and minimizes leaching of fertilizers beyond the root zone. Weather data can be used for estimating crop water requirements, and is a handy management tool when it is used in conjunction with scheduling methods.

Water use is directly proportional to plant growth. Plants use water in transpiration. They use it in a process known as transpiration. The root hairs take water from the soil. The water travels through the stem towards the leaves. The water evaporates into the air through pores in the surface of the leaves. Water is also lost when it evaporates from the soil and other surfaces. The combined loss of water through transpiration and evaporation is termed as evapotranspiration. Measuring the evapotranspiration will tell you how much water is being used by the crop. The amount of water used by the crop will depend upon the type of crop and its stage of growth. It will also depend on environmental factors such as sunlight, humidity, wind speed and temperature.

Crop water use can be measured using three methods: 1) plant-based, 2) weather-based and 3) soil-based.

Plant-based method

This method is based on the appearance of the plant in response to water stress. Wilting is a sign of water stress and some farmers may irrigate when plants start to show signs of wilting. In many cases, wilting means that the crop is already under water stress. Stress will cause plant growth to slow down. This will reduce yield and quality of the crop. Wilting and signs of plant stress may happen even when there is water in the soil. For example, some plants roll their leaves or wilt in the middle of a hot, windy day. Wilting is also a sign of

water-logging or root diseases. This method is not always reliable in monitoring crop water use.

Weather-based method

Weather affects crop evapotranspiration. Hence, measurement of evapotranspiration (ET) provides estimates of water use by the crop. Evapotranspiration is calculated using a “reference crop.” The reference crop is an extensive surface of green grass cover of uniform height, actively growing, completely shading the ground and not short of water. Reference crop evapotranspiration (ET_o) can be found at a local weather station. This information indicates how much water the reference crop has used each day. The particular crop of interest will be different from the reference crop.

Soil water-based method

This method of measurement is based on the amount of water in the soil and calculation of the amount of water needed to refill the readily available water (RAW). There are three basic methods for finding the amount of water held in the soil: 1) gravimetric, 2) volumetric, and 3) tension. Gravimetric method is done by drying a soil sample in the oven. The decrease in unit weight over that of field capacity represents the amount of water loss or used by the crop. Volumetric method uses nuclear or electrical methods such as gypsum blocks. The effort a plant has to use to extract water held by soil is measured by a tensiometer and expressed in centibars (cb) or kilo Pascals (kPa). Each method of measuring the amount of water held in the soil has advantages and disadvantages. Select the tool that is best suited for your farm.

The amount of water required to supplement crop water needs depends on crop type, local climate, and soil conditions (Fig. 33). Integrating information calculated by different methods allows one to evaluate plant water relation with respect to soil-plant-atmosphere continuum. This allows growers or irrigation designers to estimate how much water will be required during the cropping season, and how best to deliver it to meet the crop’s peak demand. This approach is most effective when used in conjunction with other scheduling techniques.

Estimating crop water use by the moisture-accounting method

The Moisture Accounting Method involves steps to estimate soil moisture content by using weather data. It is based on a soil water balance. For instance, if the moisture content of a soil is known at any given time, the moisture content at any later time can be computed by adding water gains (effective rain and/or irrigation) and subtracting water losses (run-off, deep percolation and crop evapotranspiration - ET_c) during the elapsed period.

Keeping the daily water balance is a simple procedure, but it must be completed each day. By knowing the daily values for inflow (rainfall or irrigation) and outflow (crop water use), the daily balance can be calculated as shown in Table 11. As soon as the accumulated water

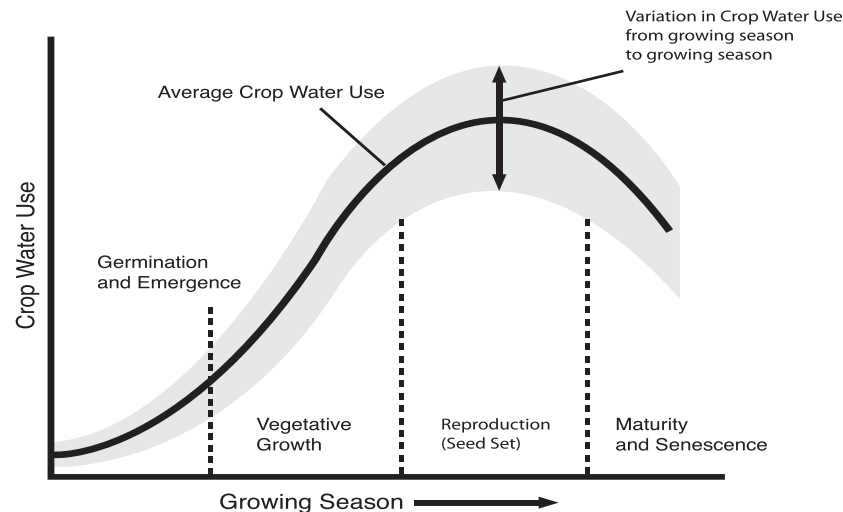

Figure 33. Typical water use curve for most agronomic crops. (NSW DPI, 2008c)

deficit exceeds the value of the net irrigation application depth (i.e. the net amount of irrigation water applied), more irrigation water is supplied to maintain optimum soil moisture content for plant growth. Three factors determine the amount of water used by crops as follows:

1. Crop factor: The data on crop rooting depth (Table 9), growth stages and crop coefficient (Table 10) are required for the moisture accounting.

The length of the total growing season and each growth stage of the crop are important when estimating crop water needs. The growth of an annual crop can be divided into four stages:

- Initial (establishment): from sowing to 10% ground cover
- Crop development : from 10 to 70% ground cover
- Mid-season (fruit formation): including flowering and fruit set or yield formation
- Late-season: including ripening and harvest.

A crop coefficient (K_c) relates crop water use at a particular development stage to the amount of evapotranspiration (ET) calculated from weather data. Table 10 shows the crop coefficient (K_c) for selected vegetable crops at various stages of growth.

Crop evapotranspiration is calculated using the equation:
 $ET_c = K_c \times ET_o$ (Fig. 34).

Table 10. Crop coefficient (Kc) for various growth stages of selected vegetable crops (Doorenbos and Kassam, 1979)

Crop	Initial	Development	Mid season	Late	At harvest
Cabbage	0.4 ¹ - 0.5 ²	0.7 - 0.8	0.95 - 1.1	0.9 - 1.0	0.8 - 0.95
Carrots	0.4 - 0.6	0.6 - 0.75	1.0 - 1.15	0.8 - 0.9	0.7 - 0.80
Cucumber	0.4 - 0.5	0.7 - 0.8	0.95 - 1.05	0.8 - 0.9	0.65 - 0.75
Lettuce	0.3 - 0.5	0.6 - 0.7	0.95 - 1.1	0.9 - 1.0	0.8 - 0.95
Onions dry	0.4 - 0.6	0.7 - 0.8	0.95 - 1.1	0.85 - 0.9	0.75 - 0.85
Onions green	0.4 - 0.6	0.6 - 0.75	0.95 - 1.05	0.95 - 1.05	0.95 - 1.05
Pepper	0.3 - 0.4	0.6 - 0.75	0.95 - 1.1	0.85 - 1.0	0.8 - 0.9
Tomato	0.4 - 0.5	0.7 - 0.8	1.05 - 1.25	0.8 - 0.95	0.6 - 0.65

¹The first crop reading is for high humidity and low wind conditions, ²The second reading is for low humidity and strong wind conditions. Source: Doorenbos and Kassam (1979).

Where: ET_c = Crop Evapotranspiration
 K_c = Crop Coefficient
 ET_o = Reference Evapotranspiration

Figure 34. Calculating crop evapotranspiration (ET_c) (Qassim and Ashcroft, 2006)

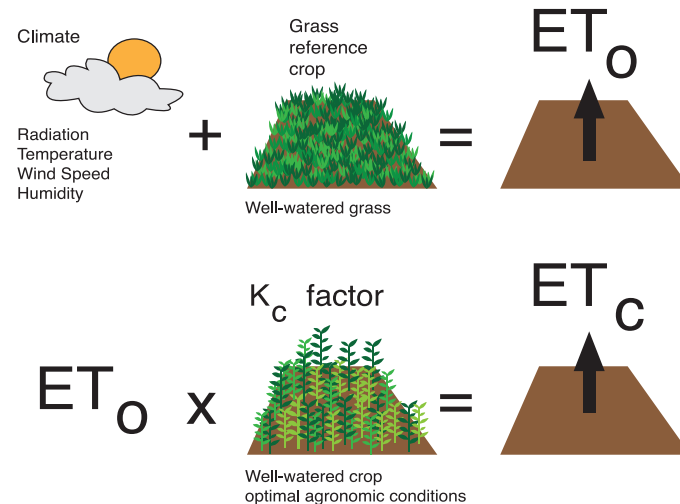

Table 11 shows the critical growth stages of crops for determining irrigation water needs.

2. Soil factor (Total and readily available water): Ideally, a soil should hold enough water to facilitate plant growth, and have the capability to drain away any excess. It is important to understand the way in which water behaves in the soil if irrigation efficiency is to be maximized. Total available water (TAW), readily available water (RAW) and depletion fraction (p) are critical to planning an appropriate irrigation schedule. To maintain soil moisture at optimum levels, it is important to understand that not all of the total available water is used before the next irrigation is applied. TAW is lowest in sandy (S) soils and greatest in heavy clay (HCL) soil: $S < SL < L < LCL < CL < HCL$. Generally the RAW is only about 50% TAW.

3. Climate factor: Water is lost from the soil surface by **evaporation** and from the crop via **transpiration**, i.e. in total **evapotranspiration (ET)**. Water losses through ET are influenced by weather conditions (temperature, wind, solar radiation and relative humidity), and are estimated using these factors.

The crop, soil and climate factors can be modified to improve the water use efficiency of vegetable crops.

The moisture accounting method is illustrated in Table 12, for a tomato crop grown in clay soil. As soon as the accumulated deficit exceeds 40 mm, a further irrigation is supplied.

To use the moisture balance sheet, complete the following steps:

Decide which crop will be grown (e.g. tomatoes).

- Estimate or measure root depth by digging a hole next to the crop, or alternatively use Table 6.
- Find out the soil type and determine total available water (Table 6).
- Decide on an appropriate depletion fraction (p) roughly 0.3-0.5 for vegetable crops.
- Calculate readily available water = depletion fraction (p) of total available water.
- Calculate net irrigation application depth (mm) = root depth readily available water. Record reference evapotranspiration (ET_0) from climate data or calculate it from pan evaporation.
- Multiply ET_0 in mm/day (column A) by the appropriate crop coefficient (K_c) value (column B) to obtain crop water needs.
- Record daily rainfall and estimate effective rainfall (mm) (column D & E).
- Add up column H for all water deficits since the last irrigation and subtract effective rainfall. (After an irrigation event the soil is saturated and crop water use is assumed to be zero).

Table 11. Critical growth stage of crops, and crop total water use, for determining irrigation water needs (Doorenboos and Kassam, 1979)

CROP	CM/HA	CRITICAL NEED STAGE
Asparagus	63-115	establishment and fern development
Bean, green	63-95	bloom and pod set
Bean, pinto	95-125	bloom and pod set
Beet, table	63-95	establishment and early growth
Broccoli	125-160	establishment and heading
Cabbage	125-190	uniform throughout growth
Cantaloupe	83-125	establishment vining to first net
Carrot	63-95	emergence through establishment
Cauliflower	125-190	establishment and 6 - 7 leaf stage
Celery	190-223	uniform, last month of growth
Collards/kale	75-90	uniform throughout growth
Corn, sweet	125-223	establishment, tassel elongation, ear development
Cowpea	63-95	bloom, fruit set, pod development
Cucumber, pickle	95-125	establishment, vining, fruit set
Cucumber, slicer	125-160	establishment, vining, fruit set
Eggplant	125-223	bloom through fruit set
Garlic	95-125	rapid growth to maturity
Lettuce	50-75	establishment
Mustard green	63-95	uniform throughout growth
Okra	95-125	uniform throughout growth
Onion	160-190	establishment, bulbing to maturity
Pepper, bell	160-223	establishment, bloom set
Pepper, jalapeno	160-190	uniform throughout growth
Potato	125-255	vining, bloom, tuber initiation
Pumpkin	160-190	2-4 wks after emergence, bloom, fruit set and development
Radish, red globe	33-63	rapid growth and development
Spinach	63-95	uniform throughout growth, after each cut if needed
Squash	45-63	uniform throughout growth
Sweetpotato	63-125	uniform until 2 - 3 wks prior to anticipated harvest
Tomato	125-160	bloom through harvest
Turnip	63-95	uniform throughout growth
Watermelon	63-95	uniform until 10 - 14 days prior to anticipated harvest

Soil water relationships and irrigation water requirements of various vegetable crops are presented in Table 13.

Table 12. Moisture balance sheet for scheduling irrigation in a tomato crop (NSW DPI, 2008c)

Crop: Tomatoes Soil type: Clay Month: January		Effective root depth (D_{rz})= 0.55m , $p = 0.4$, TAW = 180 mm/m, RAW = 0.480 = 72 mm Net irrigation depth = $D_{rz} \times RAW = 0.55 \times 72 = 39.6$ (~40 mm) (step 6)					
	A	B	C = A B	D	E = D - 5mm	F	H = (E+F) - C
Day	ET _o (mm/day)	Crop coefficient (K _c)	Crop water use (ET _c) (mm/day)	Rainfall (mm)	Effective rain (mm) ¹	Irrigation application d _{net} (mm)	Cumulative soil water deficit (mm)
1	7.6	0.85	6.5	0	0	0	-6.5
2	8.6	0.85	7.3	3.8	0	0	-13.8
3	8.6	0.85	7.3	0.4	0	0	-21.1
4	8.8	0.85	7.5	0	0	0	-28.6
5	7.1	0.85	6.0	0	0	0	-34.6
6	9.1	0.85	7.7	0	0	40	Irrigation
7	6.4	0.85	5.4	0	0	0	0.00
8	3.4	0.85	2.9	0	0	0	-2.9
9	6.2	0.85	5.3	6	1	0	-8.2
10	6.3	0.85	5.4	3.2	0	0	-13.6
11	4.3	0.85	3.7	4.6	0	0	-17.3
12	7.7	0.85	6.5	1.4	0	0	-23.8
13	8.7	0.85	7.4	17.8	12.8	0	-11.0
14	7.2	0.85	6.1	0	0	0	-17.1
15	7.0	0.85	6.0	0	0	0	-23.1
16	8.4	0.85	7.1	0	0	0	-30.2

¹To calculate effective rainfall, during spring, summer and autumn periods, subtract 5 mm from each of the daily rainfall totals. Assume rainfalls of 5 mm or less to be non-significant (zero for crop water use). In winter, all the rainfall is assumed to be effective.

Table 13. Soil water relations and irrigation requirements of various vegetable crops (Doorenbos and Peruit, 1992)

Crop	Preferred soil moisture		Amount/ cm in "X" Days	Irrigation Critical Moisture Period	Preferred Irrigation Method (2)	Drought Toler- ance (3)	Root- ing Depth (4)	Defects Caused by Water Deficit	Comments
	Bars (-)	ASM (1)							
Asparagus	0.70	40%	2.5/20	Crown set, and transplanting	a,b	H	D	Shriveling	Withstand most drought
Beans, dry	0.45	50%	2.5/7	Flowering	a	M	M	Poor pod & beans	Drying pod-no irrigation
Beans, lima	0.45	50%	2.5/7	Flowering	a,b	L-M	D	Poor pod & beans	Cooling irrigation better
Beans, pole	0.34	60%	2.5/5	Flowering	a	L-M	M	Poor & pithy pods	Steady moisture - flowering
Beans, snap	0.45	50	2.5/7	Flowering	a	L-M	M	Poor & pithy pods	Irrigation prior to flowering has little benefit
Veg. soybean	0.70	40%	2.5/14	Flowering	a,b	M	M	Poor pod fill	--
Beet	2.00	20%	2.5/14	Root expansion	a,b	M	M	Growth cracks	
Broccoli	0.25	70%	2.5/5	Head development	a,b,c	L	S	Strong flavor	
Brussels sprout	0.25	70%	2.5/5	Sprout formation	a,b,c	M	S	Poor sprout production	
Cabbage	0.34	60%	2.5/10	Head development	a,b	M-H	S	Growth cracks	
Cantaloupe	0.34	60%	2.5/10	Flowering, fruit development	a,b	M	S-M		
Carrot	0.45	50%	2.5/21	Seed germination root expansion	a,b	M-H	S-M	Growth cracks, misshapen roots	Avoid droughts during root expansion
Cauliflower	0.34	60%	2.5/5	Head development	a,b,c	L	S	Ricey curd, buttoning	
Celery	0.25	70%	2.5/5	Continuous	a,b,c,d	L	S	Small petioles	Moisture deficit can stop growth irreversibly
Chinese cabbage	0.25	70%	-2.5/5	Continuous	a,c	L	S	Tough leaves	
Collards	0.45	50%	2.5/14	Continuous	a,b,c	M	S	Tough leaves	
Corn, sweet	0.45	50%	2.5/14	Silking	a,b	M-H	S	Poor ear fill	Irrigation prior to silking has little value
Cucumber, pickles	0.45	50%	2.5/7	Flowering and fruiting	a,b,c	L	S-M	Pointed and cracked fruit	Moisture deficit drastically reduce yield and quality
Cucumber, slicer	0.45	50%	2.5/7	Flowering and fruiting	a,b,c	L	S-M	--	--
Eggplant	0.45	50%	2.5/7	Flowering and fruiting	a,b,c	M	M	BER,misshapen fruit	
Greens (turnip, mustard, kale)	0.25	70%	2.5/7	Continuous	a,b	L	M	Tough leaves	Good continuous moisture essential to good yield
Leek	0.25	70%	2.5/5	Continuous	a,b	L-M	S	Thin scale	
Lettuce	0.34	60%	2.5/7	Head expansion	a,b		D	Small leaves	

Crop	Preferred soil moisture		Amount/ cm in "X" Days	Irrigation Critical Moisture Period	Preferred Irrigation Method (2)	Drought Toler- ance (3)	Rooting Depth (4)	Defects Caused by Water Deficit	Comments
	Bars (-)	ASM (1)							
Okra	0.70	40%	2.5/14	Flowering	a,c	M-H	D	Tough pods	Irrigation can reduce yield
Onion	0.25	70%	2.5/7	Bulb development	a,b	L	S	Poor size	
Parsnip	0.70	40%	2.5/14	Root expansion	a,b	H	D		
Peas, Garden)	0.70	40%	2.5/7	Flowering	a	L	M	Poor pod fill	
Peppers	0.45	50%	2.5/7	Transplanting flower-fruit growth	a,b,c	M	M	Shriveled pods, blossom-end rot	Irrigate for increased pod size and yield
Potato, Irish	0.35	70%	2.5/7	After flowering	a,b	M	S	Regrowth and misshapen roots	Irrigate at drought during root development
Pumpkin	0.70	40%	2.5/14	Fruiting	a,b	M	D	Blossom-end rot	
Radish	0.25	70%	2.5/5	Continuous	a	L	S	Pithy roots	Good soil moisture needed for rapid growth
Rhubarb	2.00	20%	2.5/21	Leaf emergence	a,b	M	D	Pithy stems	
Rutabagas	0.45	50%	2.5/14	Root expansion	a,b	M	M	Tough roots	
Southern peas	0.70	40%	2.5/14	Flowering and pod swelling	a,b	M	M	Poor pod fill	Plants recover from drought but yield is reduced
Squash, summer	0.25	70%	2.5/5	Fruit sizing	a,c	L	M	Pointed and misshapen fruit	Fruit sizing. Irrigation can double or triple yields
Squash, winter	0.70	40%	2.5/10	Fruit sizing	a,b	M	D		
Sweet potato	2.00	20%	2.5/21	Fruit & last 40 days	a,b	H	D	Small, misshapen roots	
Tomato, staked	0.45	50%	2.5/5	Fruit expansion	a,c	M	D	Blossom and root growth cracks	Good moisture avoid BER and increase fruit size
Tomato, ground	0.45	50%	2.5/7	Fruit expansion	a,b	M	D	Blossom and root growth cracks	
Tomato, process	0.45	50%	2.5/7	Fruit expansion	a,b	M	D	Blossom and root growth cracks	
Turnip	0.45	50%	2.5/10	Root expansion	a,b	M	M	Woody roots	
Watermelon	2.00	40%	2.5/21	Fruit expansion	a,b,c	M-H	D	Blossom end rot	tolerate drought, low yield

(1) ASM (Available Soil Moisture). Percentage of soil water between field capacity (-0.1 bar) and permanent wilting point (-15 bars).

(2) Irrigation method: a = Sprinkler; b = Big Gun; c = Trickle (drip); d = Flood.

(3) Drought tolerance: L = low; M = moderate, needs irrigation most years; H = high, seldom needs irrigation.

(4) Depth of rooting of most roots: S = shallow, 30-46 cm; M = moderate, 46-61 cm; D = deep, 61 cm plus.

NOTES

CHAPTER 8

Irrigation Water Quality



Irrigation water quality and drip irrigation with recycled water

The quality of irrigation water has profound effects on the soil, crops, and irrigation infrastructure. Common soil problems associated with water quality are related to salinity, water infiltration rate, ion toxicity, and long term structural changes in the soil. Laboratory determinations and calculations needed to use the guidelines are given in Tables 14 and 15.

Growing trends towards concentrated population in the cities will increase the access for treated waste water in the peri-urban area for horticultural crops in the future. Wastewater reuse for agriculture and managed landscapes will aid in meeting growing water demands and conserve current potable supplies in many parts of the world. Therefore, opportunities exist to use alternative water supplies for irrigation such as treated municipal wastewater. However, wastewaters often contain microbial and chemical contaminants that may affect public health and environmental integrity. Wastewater pretreatment strategies and advanced irrigation systems may limit contaminant exposure to crops and humans. Subsurface drip irrigation (SDI) shows promise for safely delivering reclaimed wastewater. The closed system of SDI pipes and emitters minimizes the exposure of soil surfaces, above ground plant parts, and groundwater to reclaimed wastewater. The potential for salt and sodic hazard in soils increases with wastewater irrigation but with SDI the total water input, and, therefore, the salt load can also be minimized. Beneficial and safe use of reclaimed wastewater for SDI will depend on

management strategies that focus on irrigation pretreatment, virus monitoring, field and crop selection, and periodic leaching of salts.

Optimization of SDI has been further achieved by the latest development of oxygation (Bhattarai and Midmore, 2009). Oxygation (using aerated water with subsurface drip irrigation) improves yield and water use efficiency of vegetable production under saline and non-saline soil conditions. An inline air injector, suitable for home gardening, can be operated with the pressure in the drinking water tap. Burying the drip tape just a few centimeters below the soil surface increases the utility of drip irrigation by reducing the evaporative loss of soil water and maximizes the benefit of oxygation in a number of crops. This also keeps the weed growth down as the surface is dry, and offers the opportunity for maximization of infiltration of rain water into the soil profile.

Table 14. Guideline for interpretations of water quality for irrigation¹

Potential Irrigation Problem				Units	Degree of Restriction on Use		
					None	Slight to Moderate	Severe
Salinity(affects crop water availability) ²							
	ECw			dS/m	< 0.7	0.7 – 3.0	> 3.0
	(or)						
	TDS			mg/l	< 450	450 – 2000	> 2000
Infiltration (affects infiltration rate of water into the soil. Evaluate using ECw and SAR together) ³							
SAR	= 0 – 3	and ECw	=		> 0.7	0.7 – 0.2	< 0.2
	= 3 – 6		=		> 1.2	1.2 – 0.3	< 0.3
	= 6 – 12		=		> 1.9	1.9 – 0.5	< 0.5
	= 12 – 20		=		> 2.9	2.9 – 1.3	< 1.3
	= 20 – 40		=		> 5.0	5.0 – 2.9	< 2.9
Specific Ion Toxicity (affects sensitive crops)							
	Sodium (Na) ⁴						
	surface irrigation			SAR	< 3	3 – 9	> 9
	sprinkler irrigation			me/l	< 3	> 3	
	Chloride (Cl) ⁴						
	surface irrigation			me/l	< 4	4 – 10	> 10
	sprinkler irrigation			me/l	< 3	> 3	
	Boron (B) ⁵			mg/l	< 0.7	0.7 – 3.0	> 3.0
	Trace Elements (see Table 21)						
Miscellaneous Effects (affects susceptible crops)							
	Nitrogen (NO ₃ - N) ⁶			mg/l	< 5	5 – 30	> 30
	Bicarbonate (HCO ₃)						
	(overhead sprinkling only)			me/l	< 1.5	1.5 – 8.5	> 8.5
	pH				Normal Range 6.5 – 8.4		

¹ Adapted from University of California Committee of Consultants 1974.

² ECw means electrical conductivity, a measure of the water salinity, reported in deciSiemens per meter at 25°C (dS/m) or in units millimhos per centimeter (mmho/cm). Both are equivalent. TDS means total dissolved solids, reported in milligrams per liter (mg/l).

³ SAR means sodium adsorption ratio. SAR is sometimes reported by the symbol RNa. See Figure 1 for the SAR calculation procedure. At a given SAR, infiltration rate increases as water salinity increases. Evaluate the potential infiltration problem by SAR as modified by ECw. Adapted from Rhoades 1977, and Oster and Schroer 1979. ⁴ For surface irrigation, most tree crops and woody plants are sensitive to sodium and chloride; use the values shown. Most annual crops are not sensitive; use the salinity tolerance tables (Tables 4 and 5). For chloride tolerance of selected fruit crops, see Table 14. With overhead sprinkler irrigation and low humidity (< 30 percent), sodium and chloride may be absorbed through the leaves of sensitive crops.

⁶ NO₃ -N means nitrate nitrogen reported in terms of elemental nitrogen (NH₄ -N and Organic-N should be included when wastewater is being tested).

Source: Ayers and Westcott, 1985.

Table 15. Laboratory determinations needed to evaluate common irrigation water quality problems (Ayers and Wescott, 1985)

Water parameter	Symbol	Unit ¹	Usual range in irrigation water	
SALINITY				
Salt Content				
Electrical Conductivity	EC _w	dS/m	0 – 3	dS/m
(or)				
Total Dissolved Solids	TDS	mg/l	0 – 2000	mg/l
Cations and Anions				
Calcium	Ca ⁺⁺	me/l	0 – 20	me/l
Magnesium	Mg ⁺⁺	me/l	0 – 5	me/l
Sodium	Na ⁺	me/l	0 – 40	me/l
Carbonate	CO ₃ ⁻⁻	me/l	0 – .1	me/l
Bicarbonate	HCO ₃ ⁻	me/l	0 – 10	me/l
Chloride	Cl ⁻	me/l	0 – 30	me/l
Sulphate	SO ₄ ⁻⁻	me/l	0 – 20	me/l
NUTRIENTS				
Nitrate-Nitrogen	NO ₃ -N	mg/l	0 – 10	mg/l
Ammonium-Nitrogen	NH ₄ -N	mg/l	0 – 5	mg/l
Phosphate-Phosphorus	PO ₄ -P	mg/l	0 – 2	mg/l
Potassium	K ⁺	mg/l	0 – 2	mg/l
MISCELLANEOUS				
Boron	B	mg/l	0 – 2	mg/l
Acid/Basicity	pH	1–14	6.0 – 8.5	
Sodium Adsorption Ratio	SAR	(me/l)	0 – 15	

¹ dS/m = deciSiemen/meter in S.I. units (equivalent to 1 mmho/cm = 1 millimho/centi-metre)

mg/l = milligram per liter □ parts per million (ppm).

me/l = milliequivalent per liter (mg/l ÷ equivalent weight = me/l); in SI units, 1 me/l = 1 millimol/liter adjusted for electron charge.

ems

CHAPTER 9

Irrigation System Assessment



Irrigation system assessment

An Irrigation System Assessment evaluates the irrigation system performance to ensure that it is operated to match the crop, soil and climate conditions present. Irrigation is scheduled to replace the climate moisture deficit in a manner that does not exceed the crop's ability to utilize the water, or the soil's capacity to store the water applied.

A key objective of an Irrigation System Assessment is to ensure that water is used efficiently and will meet the crop's water needs while preventing water loss due to surface flow, leaching or drift. Appropriate irrigation equipment selection and design, as well as good management and scheduling, will conserve water supplies while supporting crop growth. Evapotranspiration (ET) is the driver that determines how much water is being used by the plant. The climate moisture deficit is the difference between the accumulated ET and the effective rainfall. ET is used to determine the irrigation system peak flow rate and annual crop water requirement.

An Irrigation System Assessment can benefit farm productivity, enhance protection of the environment, as well as benefit the environment by conserving water and preventing nutrient losses. For the farm, good water management means:

- Knowing the farm's irrigation requirements and reducing unnecessary water usage
- Saving energy by operating the system efficiently
- Reducing runoff and leaching of nutrients beyond the plant's rooting depth
- Maximizing crop yield

To complete an Irrigation Management Plan, irrigation systems must be assessed for distribution uniformity (DU) and application efficiency. Once irrigation system performance has been checked and improved if necessary, an irrigation schedule can be developed. DU is a measurement of the evenness of water application over a field, and is expressed as a percentage. Application efficiency is an indication of the percentage of water applied by the irrigation system that is actually available in the right place at the right time. The distribution uniformity of the low cost drip system can be assessed by measuring the volume of water over the irrigation period in random catch cans in the field, per one emitter.

CHAPTER 10

Socioeconomic Evaluation of Small-scale Drip Irrigation



Basic economic evaluation of small-scale drip irrigation

To ensure the successful adoption of a farming technology, the new technology should perform better than existing farm technology, help farmers increase productivity, generate substantially higher income, and save on capital and/or labor costs. Farmers are willing to invest in new technology when they feel adequate economic benefits will accrue from using the new technology.

For successful technology adoption at a community- or region-wide scale, the technology recommended to smallholder farmers should generate extra benefits, but should not impose a major risk for crop failure. The level of risk associated with a technology is a critical factor governing farmers' adoption behavior, as excessive risk would deter many potential smallholder farmers from adopting the technology. A technology becomes risky when it is a "large" (needs high investment) or a "lumpy" (useful for a specific purpose only) asset.

A new technology recommended by extension agents or agriculture service providers is more likely to be adopted when farmers are aware of the economic benefits of replacing the old technology or practice. Thus, an economic assessment of low-cost drip technology, as illustrated in this chapter, is an important aspect of assessing technology performance in the field and validating the technology. A technology must also perform well economically, make efficient use of resources, and promote financial sustainability.

Wide adoption of low-cost drip irrigation technology brings benefits to the community at large in terms of increased crop production and food security, increased employment opportunities (especially for landless households), and lower prices for local produce. Increasing

cropping intensity and increasing employment at certain critical periods of the year is an important aspect of rural development. There are two types of economic benefits that accrue from the adoption of a new technology by a farmer:

- a) **Farm level benefits.** Most of the benefits are realized by the farmers adopting the technology, for example, increased crop productivity, increased cropping intensity, increased farm income. This also includes reduced cost of scarce resources, lower cost or less need for hired labor, or less need for chemicals or irrigation water.
- b) **Community or social benefits.** These benefits include increased employment availability per hectare of land, increased availability of employment at critical periods of the year when work is not available locally, reduced produce prices (although farmers may lose out on this), etc.

A good economic evaluation of technology adoption should quantify both the farm and community level benefits of the technology. It should be noted that assessing community-level benefits is demanding, and time is needed to realize the full scale of these benefits in the technology adoption process.

Economic analysis at the farm level provides information about the economic viability of the technology based on the decision making behavior of individual farmers. A farm level economic analysis of drip technology can be performed in two ways: 1) Partial budget analysis, or 2) farm enterprise budget analysis. The method a practitioner chooses depends on resources, time, and economic information available.

1. Partial budget analysis of the drip technology

A partial budget analysis of crop production activities with and without drip technology provides a good snapshot of information on financial viability of the technology in relation to farmers' level of investment. This sheds light on the scale of economic benefits that accrue to the farmer adopting the drip technology, and the effective use of scarce resources (scarce capital and labor).

In the first or second years of adopting small-scale drip technology, no major change would occur on structure of farm, land use changes etc., but only such change would occur at the production practices of selected two crops, increased crop intensity using the drip irrigation technology, and increased crop yield and of farm employment and farm income. Hence, a simple economic assessment using a framework of partial budgeting serves the purpose, which is also easy and convenient to gauge economic viability of the technology instantly and with limited need of expertise to carry out such economic analysis. Experts from other disciplines can also carry out the partial budget analysis.

To carry out partial budget analysis, we need to know only those changes on cost and benefits of the farm enterprises that are caused by the drip technology, i.e., additional changes brought by the decision of technology adoption, or changes at the marginal level of resources uses. Here, we do not need to analyze change on use of other farm resources brought by the technology than that of the direct impacts of the drip irrigation on crop productivity and farm return (including due to cost saving on inputs use). Its procedures and methods are illustrated in Table 16, but using some hypothetical data.

Table 16. Partial budgets to estimate to change on net farm income in a crop season due to adoption of drip technology

S. N	Negative effects	Amount	S. N	Positive effects	Amount
A	Additional cost incurred by use of the drip technology	US\$25	E	Additional annual return from the drip technology (due to increased yield)	US\$125
B	Reduced returns due to the technology	Nil	F	Reduced cost in use of input materials (labor saving, etc)	50
C	Sub Total (A+ B)	US \$25	G	Sub total (a +b)	US\$175
		Net change on income brought by the technology= G- C = 175 - 25 = US\$ 150			

Note: 1. Assume that the drip irrigation set cost US\$100, which is then divided into 2 years (or four crop seasons @ two dry season crop /year). Hence, depreciated cost of the drip technology per crop season is US\$100/4 = US\$25.

Basic steps to follow to derive the partial budget:

- Specify and estimate all of the cost components that will increase or decrease with adoption of the drip set.
- Specify and estimate all components of additional returns (increase or decrease) with adoption of the drip technology.
- If the estimated change brought by the technology is positive (i.e., if additional total return is higher than that of additional total cost) then the drip set is giving more economic benefits to the farmer than

- that of the case without use of the drip.
- Only items that are changed after the adoption of the drip technology are included in the analysis; and it is assumed that other factors that are not counted in the analysis remain unchanged after adoption of the drip technology.

2. Farm Enterprise Budget Analysis

The process of deriving farm enterprise budget table is a little more complicated than that of the partial budget analysis, but information generated from farm enterprise budget analysis is more informative. Thereby, it reflects more accurately the decision-making behavior of a typical farmer in adoption or not use of the new technology (production practices) in question. The process of producing a particular farm commodity is called as farm enterprise hence a detailed component analysis of inputs used and outputs produced while producing a farm commodity (by farm enterprise), and expressing these numbers in a more formalized way or in a monetary term, is known as Farm Enterprise Budget Analysis". For example, say production of tomato using the drip technology is considered as an enterprise A and production of tomato without drip technology (under furrow irrigation) is considered as enterprise B. Then, when the net return from the farm-enterprise A is higher than that of enterprise B, then the drip technology is considered as a profitable investment activity, or vice versa.

Basic sets of farm enterprise data needed for analyzing crop production with drip technology (enterprise A), and with out drip technology (enterprise B), are derived by:

- measuring all of the external inputs used by farmers, levels of crop yield and valuing all of them in monetary level;
- listing the level of labor (by key activities) used in production process (separated by family and hired labor use);
- Constructing the farm budget table to facilitate economic analysis (Table 17).

The economic analysis of drip is illustrated by a numerical example (a hypothetical data) and with assumptions on some of the crop production, which are as realistic as the data obtained in the context of developing countries in Asia. Comparison of some of the economic parameters such as net return, real net return and ratio of real return to investment across the alternate investment (enterprises) provide improved and more realistic information for farm investment decision.

Major assumptions made while deriving enterprise budget in Table 16 are listed below.

- a. Total cost of the small-scale drip set is US\$100, which is distributed evenly to four crop periods in the period of two years. Thus US\$100 as a total fixed cost of drip is equally divided into \$25 per crop season basis.
- b. The cost for application of other input materials is same for tomato production with and without drip technology. This includes cost for fertilizers, manures, pesticides, other chemicals, post harvest baskets etc., except the human labor cost
- c. In practice, the drip irrigation would reduce labor

time for irrigating a crop; hence, the total labor use under drip is assumed less than that of the drip technology. Nevertheless, because of increased yield, there would be slightly more number of labor uses for harvesting under the drip technology. These factors have been accounted in the data illustrated in Table 17.

- d. Quality of the tomato harvested under drip and without drip technology will remain same and they fetch the same market prices.

In Table 17 on the next page, economic parameters of “net return” and “real net return” are estimated separately. The parameter net return does not account for opportunity cost of using family labor in cultivation of tomato; while the parameter of real net return accounts for the opportunity cost of family labor uses in farming. In subsistence economy where rural employment level is also very high, calculating net return is acceptable for such enterprise budget analysis; but in a place where rural labor market is already tight (low unemployment level), and where real wage rate is also substantially high (specially in peak time of crop season), then estimation of parameter like “real net return” is more appropriate in terms of reflecting the actual investment behavior of an average farmers. All other economic parameters derived in Table 17 are self-explanatory, and the methods derived in estimation of these parameters are also provided under the column “remarks.”

Farmers tend to be risk-averse because of the uncertainty associated with crop yield, which depends on natural and external forces outside of a farmer’s control, such as the amount of rainfall, flooding, drought, pests and diseases, or excessive price fluctuation.

Table 17. Productivity, gross returns, and economic efficiency of production of tomato under drip and alternate technology (0.1 ha basis)

S.N	Indicators	Unit	Tomato production with drip (Enterprise A)	Tomato production without drip (Enterprise B)	Remarks
I	Return				
1	Crop productivity	Kg	3000	2000	
2	Avg. harvest crop price	US\$/kg	0.2	0.2	
I	Return				
1	Crop productivity	Kg	3000	2000	
2	Avg. harvest crop price	US\$/kg	0.2	0.2	
3	Total Gross returns		600	400	
II	Variable Cost components				
4	Total material costs (seeds, fertilizers, pesticides, harvesting baskets, etc).		150	150	All materials except labor & drip sets
5.1	Total number of family labor days employed	Days/crop	40	70	Family labor
5.2	Total hired labor employed	Days/crop	10	10	# of labor
5.3	Total labor days employed	Days/crop	50	80	Family + hired labor
6.1	Total hired labor cost	US\$	20	20	wage@ \$2/day
6.2	Total labor cost (family + hired labor)	US\$	100	160	Family labor included
7.1	Total working capital needs (total cash outlays)	US\$	170	170	(4 + 6.1)
7.2	Total variable cost used (including family labor cost)	US\$	250	310	(4 + 6.2)
8	Fixed cost (depreciation of drip equipment)	US\$	25	0	Include interest cost
9	Total Cost of the production	US \$	275	310	
III	Selected economic performance indicators				
10	Net return over purchased inputs	US\$	405	230	(3 -7.1- 8)
11	Real net return (accounting for both hired and family labor)	US\$	325	90	(3- 7.2 - 8)
12	Ratio of real net return to total production cost	Ratio	1.18	0.75	row 11/ row 7.2
13	Total production cost per kg	US\$/kg	0.09	0.08	row 9/row 1
14.	Profit (real net return) per kg of crop produced/sold	US\$/Kg	0.11	0.12	(row 3- row 13)

References

- Ayers, R.S. and D.W. Westcott. 1985. Water quality for agriculture. FAO Irrigation and Drainage Water. Rev. 1. Food and Agriculture Organization, The United Nations, Rome, Italy.
- Bhattarai, S. and D. Midmore. 2009. Oxygation enhances growth, gas exchange and salt tolerance of vegetable soybean and cotton in a saline vertisol. *J. Integrative Plant Biology* 51 (7):675-688.
- Broner, I. 2005. Irrigation scheduling. Crop Series No. 4.708. Colorado State University Cooperative Extension Service. Fort Collins, CO, USA
- Brown, M. 1982. Farm Budgets: From farm income analysis to agricultural project analysis. Johns Hopkins Univ. Press. World Bank Publication. Baltimore, MD, USA.
- Clark, G. and A.G. Smajstrla. 1998. Design consideration for vegetable crops drip irrigation system. Pp. 10-16 In: Proceedings of the Seminar on "Vegetable Production Using Plasticulture," American Society for Horticultural Science, Alexandria, VA, USA.
- Doorenbos, J. and A.S. Kassam. 1979. Yield response to water. Irrigation and Drainage Paper 33, FAO, Rome, Italy.
- Doorenbos, J. and W. Peruitt. 1992. Crop water requirements. FAO Irrigation and Drainage Paper No. 24 (Rev). Rome, Italy.
- Evans, R., D.K. and R.E. Sneed. 1996. Soil water and crop characteristics important to irrigation scheduling. North Carolina Cooperative Extension Service Pub. No. Ag 452-1.
- Gittinger, J.P. 1982. Economic Analysis of Agricultural Projects. Johns Hopkins Univ. Press. Baltimore, MD, USA.
- Globe. 2005. Soil particle size distribution. Lab Guide. http://classic.globe.gov/fctg/soil_fg_particledist.pdf.
- Goodwin, I. 2009. How to use tensiometers. AgNote No.AG 0298. Dept. of Primary Industries, Victoria, Australia. p. 1-2.
- IDE International Creating Markets for the Poor. 2004. Lakewood, Colorado, USA.
- IDE India. 2004. Manufacturing and assembling manual for affordable micro-irrigation technology (AMIT). International Development Enterprises (IDE-India), New Delhi, India.
- International Development Enterprises (IDE). 2007. Horticulture easy drip kit. User Manual.

IRRI. 1991. Basic Procedures for Agro-economic Research. IRRI, Los Banos, Laguna, Philippines.

Lamont, W. J., M.D. Orzolek, J.K. Harper, A.R. Jareff and G.L. Greaser. 2002. Drip irrigation for vegetable production. Agricultural Alternatives. Pennsylvania State University, College of Agricultural Sciences, Agricultural Research and Cooperative Extension. State College, PA USA.

Luke, G. 2006. Irrigation scheduling: How and why? Farm Note 23/1990. Dept. of Agriculture and Food. Govt. of Western Australia. p. 1-3.

Marr, C.W. and D. Rogers. 1993. Drip irrigation for vegetables. MF-1090. Kansas State University Agricultural Experiment Station and Cooperative Extension Service, Manhattan, KS, USA.

NSW DPI. 2004. Water wise on the farm. Fact Sheet. http://www.dpi.nsw.gov.au/_data/assets/pdf_file/0005/164625/soil.texture/pdf.

NSW DPI. 2008a. Water Efficiency Technologies, Module 1, Soil Management Notes. New South Wales Department of Primary Industries, Orange, NSW, Australia.

NSW DPI. 2008b. Water Efficiency Technologies, Module 2, Irrigation System Evaluation Pressurized Systems. System 8: Drip (Trickle) Systems Notes. New South Wales Department of Primary Industries, Orange, NSW, Australia.

NSW DPI. 2008c. Water Efficiency Technologies, Module 3, Measurement, Scheduling and Benchmarking Notes. New South Wales Department of Primary Industries, Orange, NSW, Australia.

Palada, M.C., S. Bhattarai, M. Roberts, N. Baxter, M. Bhattarai, R. Kimsan, S. Kan and D.L. Wu. 2008. Increasing on-farm water productivity through affordable microirrigation vegetable-based technology in Cambodia. Proc. 2nd International Forum on Water and Food. 11- 13, November 2008. Addis Ababa, Ethiopia. 5 p.

Postel, S., P. Polak, F. Gonzales and J. Keller. 2001. Drip irrigation for small farmers. A new initiative to alleviate hunger and poverty. Water Institute 26:3-13.

Qassim, A. and B. Ashcroft. 2006. Estimating vegetable crop water use with moisture accounting method. Ag. Note 1992, Dept. of Primary Industries, Victoria, Australia. p. 1-4.

Ramsey, H. 2007. Calculating readily available water. Farm Note 198. Dept. of Agriculture and Food. Government of Western Australia. p. 1-3.

Rhoades, J.D. 1977. Potential for using saline agricultural drainage waters for irrigation. Proc. Water Management for Irrigation and Drainage. ASCE, Reno, Nevada, 20-22 July 1977. p. 85-116.

Simone, E., R. Hochmuth, J. Breman, W. Lamont, D. Treadwell and A. Gazula. 2008. Drip-irrigation systems for small conventional vegetable farms and organic vegetable farms. University of Florida IFAS Extension. HS 1144.

Stirzaker, R. 2003. When to turn the water off: scheduling microirrigation within wetting front detector. *Irrigation Science* 22:177-185.

Stirzaker, R. and J. Wilkie. 2002. Four lessons from a wetting front detector. Paper presented at the Irrigation Australia Conference. 21-23 May 2002. Sydney, Australia. 7 p.